

020378

LEGISLATIVE REFERENCE LIBRARY



3 0307 00001 1489

WINTERIZING MINNESOTA'S LANDSCAPE FOR WILDLIFE



**PROVIDING FOOD AND COVER
FOR WINTERING
RING-NECKED PHEASANTS AND
ASSOCIATED RESIDENT WILDLIFE
IN MINNESOTA'S FARMLANDS**

DEPARTMENT OF NATURAL RESOURCES

SK
355
.B37
2001



Plate 1. Solid stands of switchgrass (a native prairie species) resist flattening by snow and provide excellent escape, roosting and early nesting cover for a variety of wildlife (photo by R. Kimmel).



Plate 2. Properly seeded forage sorghum plantings in blocks of ten or more acres can adequately provide both food and cover for wintering wildlife on an annual basis (photo by A. Berner).

CONTENTS - CREDITS

BE PREPARED	1
NEEDS	1
FOOD	2
Food Plots	2
Feeders	3
Nuts and Berries	3
How Much is Needed	4
Location	4
COVER	4
Herbaceous Components	5
Perennial	5
Annual	5
Woody Components	6
Riparian	6
Wildlife Woody Cover Plantings	6
Farmstead Shelterbelts	6
INFORMATION RESOURCES	7
APPENDICES	
A—Nesting and Brood Cover Requirements	9
B—Ear Corn Feeder Crib	13
C—Shelled Corn Barrel Feeder for Deer (Olson Feeder)	14
D—Shelled Corn Barrel Feeder For Upland Game	15
E—How to Establish and Manage Switchgrass	17
F—Plant and Manage Forage Sorghum Wildlife Plots	18

RECEIVED

AUG 15 2002

LEGISLATIVE REFERENCE LIBRARY

STATE OFFICE BUILDING

ST. PAUL, MN 55153

This publication was written and edited by Dr. Alfred Berner and members of the Division of Wildlife's Farmland Wildlife Populations and Research Group and Farmland Wildlife Committee.

Design and layout was provided by Dr. Alfred Berner and Corporate Graphics Commercial of North Mankato, MN.

Photographs on the cover were provided by D. Montag (upper left), D. Montag (upper right), A. Berner (lower right), and D. Montag (lower left).

MINNESOTA DEPARTMENT OF NATURAL RESOURCES

**500 Lafayette Road
St. Paul, MN 55155-4007**

2001

BE PREPARED

Winters, particularly the severe ones, always focus people's attention on the plight of wildlife. This attention, however well intentioned, comes too late and quickly wanes with melting snows and warmer temperatures. Unfortunately, the damage has already been done.

In Minnesota's farmlands, wildlife experience severe winters about every 4-7 years and very severe winters about every 10 years. And, the only way to be ready for the bad years is to have adequate food and cover areas available year round, every year.

Self-sustaining wildlife populations depend on having adequate amounts and quality of reproductive and winter habitats. Undisturbed grasslands provide the primary source of reproductive cover for many resident and migratory species in Minnesota's farmlands. Because of intensive agriculture, both reproductive and winter covers are lacking. Many wildlife populations require at least 550 acres of undisturbed grasslands (Appendix A) and one core wintering area per nine square miles just to sustain themselves, and more for the population to grow.

NEEDS

Wildlife living in Minnesota year round, or visiting only in winter, are well equipped to handle just about any weather that winter can dish out. That is, only if adequate food/cover is available.

Southern and western Minnesota, where a mosaic of native prairie and wetlands once dominated the landscape, have been converted to agricultural purposes. More than 99% of the vast grasslands and 90% of the wetlands have been drained and

plowed and are now planted annually to commodity crops (e.g., corn, soybeans, wheat, oats). As the number of farms declines, the average farming operation increases in size and becomes less diversified. Nesting and winter food/cover areas continue to be lost to additional drainage of wetlands, plowing of the few remaining grasslands, and the deterioration and removal of farmstead shelterbelts and brushy areas. The result is that the living space for wildlife in this part of Minnesota is at a premium. And, in order for a wildlife population to sustain itself, sufficient numbers of individuals within that population must live long enough to reproduce and replace themselves.

The upside of these changes is that commodity crops can provide high-energy food, which most wintering wildlife can effectively utilize to combat Minnesota's bone chilling temperatures. Unfortunately, vast acreages of these crops are usually plowed/disked down in the fall, burying critically needed food sources. Even fields left unplowed get buried under snow just when the need is most critical, or are too far from winter cover to be of any value to many wildlife species.

Providing adequate winter food and cover requires that these two components be in close proximity to each other within a complex (the closer the better), and that these complexes be strategically spaced across the landscape (Fig. 1 and 2). The spacing of winter food/cover complexes depends on the mobility of the species affected. For example, complexes managed for a highly mobile species, such as the white-tailed deer, can be five to ten miles apart. Also, in the case of deer, an effective food source can be up to two miles away from the winter cover, but should **not** be separated by a heavily traveled road. For

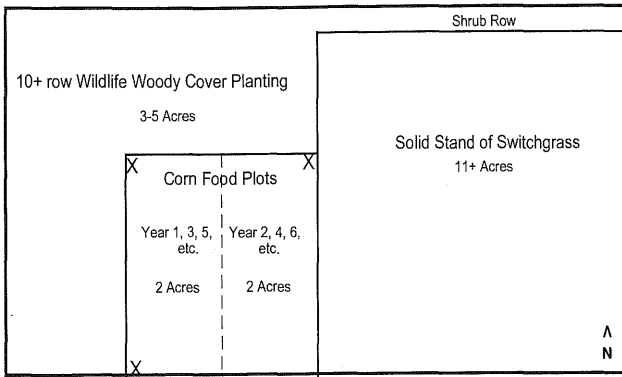

Figure 1. The composition and minimum requirements of an ideal winter food/cover complex for many wintering wildlife species in Minnesota. These complexes must be at least 20 acres in size. If deer are eating up the food plots, the addition of feeders for upland game birds and mammals is recommended. The "X"s denote the recommended locations of deer-proof feeders (see Appendix D: Fig. D4).

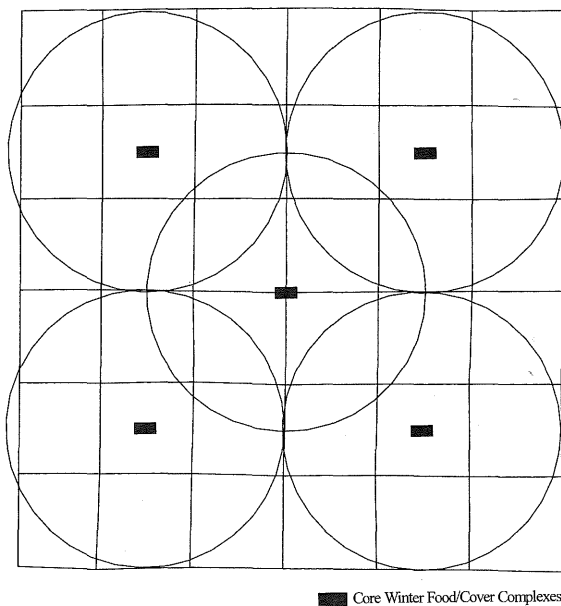

Figure 2. Ideal distribution of winter food/cover complexes (Fig. 1) for species such as the ring-necked pheasant over a township-sized area. About 54% of pheasants move less than a mile from reproductive cover to winter cover, another 22% move up to 1.5 miles (radius circles shown) and another 11% move up to 2 miles. Animals that are unable to find secure winter cover within their normal movement range are unlikely to survive the winter.

non-migratory birds and smaller mammals, however, the distances between complexes and between food and cover components must be much less. Pheasants and perhaps many song birds require at least one winter complex every three miles, and food and cover components adjacent (within 1/4 mile) to each other. And, for a species like the cottontail, the distance between complexes should be reduced to one-half mile.

The purpose of this publication is to provide the information you'll need to develop effective food/cover complexes for wintering wildlife primarily in the former prairie and now intensive agricultural areas of Minnesota (Fig. 3).

The results of your efforts, however, will not only be affected by the number and quality of the winter cover complexes you develop, but also by the amount and quality of reproductive cover in the vicinity of the wintering areas. To assist you in providing the amount and types of reproductive cover needed, refer to Norrgard (1987) and Henderson (1987) listed in the Information Resources section of this publication and Appendix A.

FOOD

A critical point to remember is *that without a reliable food source, even the best winter cover can not support wildlife in a severe winter.* A reliable food source is one that is edible, digestible, available in all types of weather and year after year, and in sufficient amounts to last the winter months (Nov-Mar) for the wildlife species present.

Food Plots

For most wildlife, *the best way to provide a reliable food source is to plant a food plot or leave a strategically located (in or immediately adjacent to cover) portion of an*

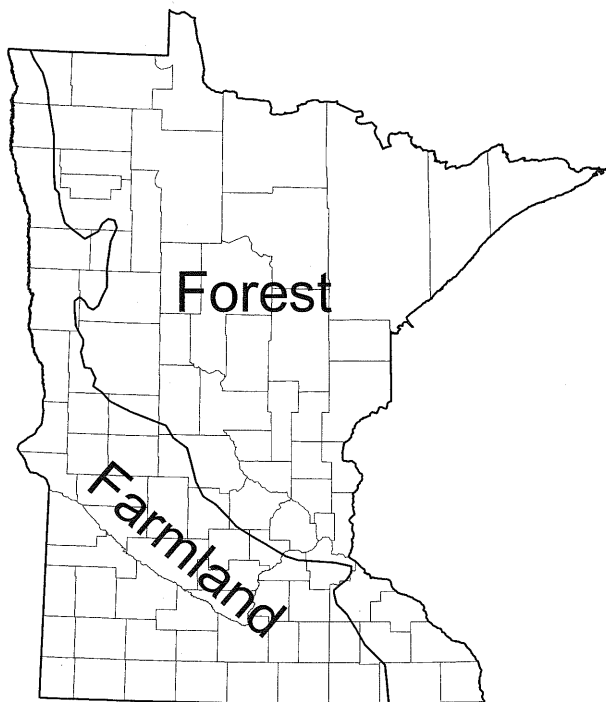

Figure 3. The portion of Minnesota that is considered the intensive farmland zone.

existing crop field. The best crops for wildlife food plots, from most to least desirable, are: corn, seed producing sorghum-sudan grass, grain sorghum, sunflowers, soybeans, wheat/oats, and millet. Although the latter three crops are used readily by wildlife, they do not stand well under winter conditions and are quickly covered by snow. In Minnesota, food plots that incorporate a mixture of the first four crops are very attractive to a wide array of wildlife species, from deer to cardinals. If large enough (5+ acres), food plots can also provide adequate winter cover for many species.

Feeders¹

The use of feeders to provide wintering wildlife with food has been highly developed for songbird use. For a thorough review of how to build and place feeders, and what to feed Minnesota's wintering songbirds, refer to Henderson (1995).

For large wildlife species (e.g., deer, pheasants, wild turkeys) feeders should be used **only** where one cannot establish a food plot, or where wildlife use is so heavy that the existing food plot is depleted before winter's end. Information on the use of feeders by these larger species is limited. From field experience, however, deer readily take to feeding on corn from piles and cribs and will use various types of feeders filled with corn or deer ration pellets. Pheasants and wild turkeys prefer to feed on waste grains or standing crops. Under severe winter conditions, however, these species will utilize cribbed corn and feeders in farmsteads or isolated locations adjacent to cover.

Establishing a feeding tradition—having food plots and/or feeders in the same general location year after year—does increase the acceptance of feeders by these species (refer to Appendix B: ear corn feeder crib; Appendix C: Olson deer feeder; and, Appendix D: upland game barrel feeder).

In situations where deer are so abundant that they devour all available food sources needed by less mobile species, such as wild turkeys and pheasants, use exclosures to eliminate deer access to the feeders. For construction design of a deer exclosure, refer to Appendix D: Fig. D4. This design excludes deer while allowing small animals access.

Nuts and Berries¹

The presence of fruiting and nut-bearing trees and shrubs adds a natural dimension to a winter complex. Nuts produced by such species as oaks, walnut and hazels provide important winter food sources for deer, wild turkeys and squirrels. Fruits that persist on the tree (e.g., hawthorne, buffalo berry, highbush cranberry, red cedar) throughout the winter can also provide very important food sources

¹ For additional technical and perhaps financial assistance, contact your local MNDNR Area Wildlife Manager.

to a variety of birds and small mammals. The availability of nuts and fruits in the fall enhances wildlife's chances of surviving the winter by significantly improving their physical condition prior to the onset of winter. However, nut and fruit production is highly variable. Therefore, one should not depend entirely on these food sources to carry most wildlife through the winter.

How Much is Needed?

When songbirds are provided most of their winter food via feeders, keeping the feeder filled and available with quality food sources throughout the winter should adequately meet their needs. When planning to provide feed for larger wildlife such as deer, pheasants and wild turkeys, however, one must know how much feed will be required to meet their energy needs. This is particularly true when planting a food plot. Assuming a deer consumes nothing other than the corn provided, the average-sized deer requires about 9.4 bushels for a 120-day winter (Dec.-Mar.). On the other hand, a wild turkey needs about 0.59 bushels per winter, while a pheasant requires only about 0.33 bushels. Therefore, an acre of 100-bushel corn could feed a maximum of 11 deer, or 169 wild turkeys, or 303 pheasants. One should increase the amount needed by 30-50% to account for use by squirrels, raccoons, etc., early use by deer (before Dec.), and consumption in excess of energy requirements.

Location

Providing the food close to the cover minimizes the exposure of feeding wildlife to severe weather conditions and to predation; these two factors account for more than 90% of winter mortality. Food sources (e.g., food plots, feeders) should be located on the leeward side (south and/or east sides),

immediately adjacent to the cover (Fig. 1) or as an integral part of the cover (e.g., sorghum-sudan plots, fruiting trees and shrubs). Food plots should be less than 1/4 mile from the cover for small animals and less than two miles for deer. Where it is not possible to have a food plot within 1/4 mile on the leeward side of the winter cover area, 4-8 rows of standing corn, 50-100 feet west and/or north of the shelterbelt in conjunction with feeders in protected areas, may suffice if adequate bushels are available. Avoid placing food near tall trees which serve as perch sites for raptors preying on the feeding birds and small mammals. Although, in the case of deer, an effective food source can be up to two miles away from the winter cover, it **should not** be separated by a heavily traveled road.

COVER

The primary functions of good winter cover are to:

1. provide protection from drifting snow
2. reduce wind chill exposure
3. provide escape cover from predators

These functions can be marginally provided in mild to moderately severe winters by one or the other of the following:

1. large blocks (10+ acres and 600+ feet on a side) of herbaceous cover (e.g., cattails, cane (*Phragmites*), switchgrass, sorghum-sudan grass, narrow-rowed corn).
2. well-designed 3+ acre wildlife woody cover plantings or farmstead shelterbelts, or existing 3+ acre woodlots with evergreens and/or heavy shrub layer.

For severe winters, both herbaceous and woody cover are needed.

The **ideal complex must be at least a 20-acre block** comprised of a 3-5 acre shrub

and evergreen planting north and/or west of an adjacent 10+ acre block of heavy herbaceous cover, and a 2-4 acre corn food plot; remember, *without a reliable food source, even the best winter cover cannot support wildlife* in severe winters (Fig. 1). Woody cover plantings, however, **should not** be planted in areas that are being managed for species that depend on large, uninterrupted grasslands (e.g., prairie chicken, upland sandpiper), or species that are vulnerable to cowbird parasitism (e.g., bobolink, dickcissal).

Herbaceous Components

Perennial

Restoring wetlands¹ (10+ acres) which develop heavy cattail and/or cane stands can be a very effective way of providing cover for a variety of Minnesota's wintering wildlife. Wetlands are particularly important to wintering songbirds, pheasants, deer and rabbits. In existing and restored wetlands, managing water levels and controlling muskrat populations can increase the area in cattail and/or cane. Where possible, develop a shrub snow catch 100-150 feet north and/or west, and a 1+ acre block of sandbar willow east and/south of the wetland (Fig. 4).

In upland situations, perennial, herbaceous, winter cover can be created by establishing or converting existing cool season, tame grasslands (e.g., brome, bluegrass, quackgrass) to a solid stand of switchgrass² (Plate 1; inside front cover). Stands of mixed native grasses (e.g., big bluestem, Indian grass) are also attractive, but are not as resistant to flattening by snow as solid switchgrass. Stands of switchgrass provide excellent cover eight of ten winters as well as year round escape and early nesting cover. Under normal conditions, switchgrass can be established in 2-3 years (Appendix E).

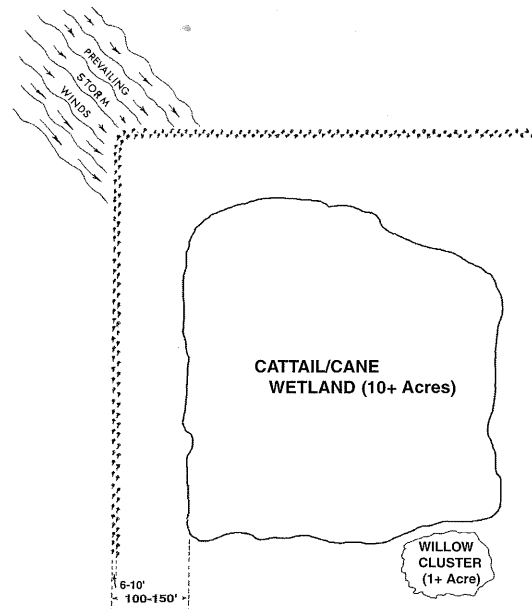

Figure 4. Strategically located shrub plantings can protect a cattail/cane wetland from drifting snow and enhance its attractiveness to wintering and nesting wildlife. Note the shrub snowcatch plantings to the north and west of the wetland and the sandbar willow cluster planting (1+ acres) in the southeast corner of the wetland.

Maintenance entails early spring burning or mowing of all or part on a 4-6 year rotation.

Annual³

Isolated 10+ acre blocks seeded to sorghum-sudan grass or narrow-rowed corn, or 5+ acres on the leeward side of a marginal woody cover planting or shelterbelt, can provide winter food and herbaceous cover within one growing season on an annual basis (Plate 2; inside cover, and Appendix F: Figs. F1, F2, and

¹ Wetland restoration provides many other benefits including habitat for many migratory waterfowl, shorebirds and songbirds, amphibians and reptiles, and furbearers, and water retention and ground water recharge. Both financial and technical assistance can be obtained from the MNDNR (Wildlife and Waters), MN Soil and Water Conservation Districts, U.S. Fish and Wildlife Service, and USDA Natural Resources Conservation Service.

² Nebraska Pathfinder or Illinois Cave-in-Rock are recommended varieties only in this situation because they are more rigid and resist lodging by snow better than local switchgrass varieties.

³ For technical and financial assistance contact your local MNDNR Area Wildlife Manager and/or the USDA Natural Resources Conservation Service, and refer to Norrgard (1985) listed in the Information Resources section of this publication.

F3). Narrow-rowed corn and certain varieties of sorghum-sudan grasses not only provide effective cover but also food. If the sorghum-sudan variety does not provide viable seed for food, a small corn plot or several feeders on the leeward side can provide the needed food. Although this technique provides excellent cover quickly, it does have two drawbacks. First, it must be planted every year. Second, it produces large amounts of residue that the farmer must contend with when preparing the site for cropping. While developing more permanent solutions, however, this technique is very useful.

Woody Components

Riparian

Restoration of flood-prone areas and slopes adjacent to rivers and streams can provide sheltered areas for a variety of wintering wildlife as well as protect large areas on the leeward sides from wind and drifting snows. Tree and shrub species native to Minnesota's riparian areas, which are capable of surviving periodic, flooding and stabilizing the adjacent slopes, should be used for restoration. This can be accomplished by allowing succession to occur and/or by planting a variety of trees and shrubs. For example, in flood-prone areas, willows, dogwoods, cottonwood and silver maple do best. On the upland slopes, green ash, hackberry, black walnut, red cedar, oaks, hazels, dogwoods, plum, chokecherry, hawthorne and viburnums are appropriate.

The larger the woody cover acreage is, the more protection from drifting snow it can provide for both humans and wildlife. To enhance wildlife values, shrub snow catches along the upland edges on the west and north banks provide protection from drifting snow. On the leeward sides, dense shrub and evergreen (native red

cedar) plantings provide valuable escape and roosting areas. In addition to providing critically needed winter cover, these large woody areas provide important nesting and feeding areas for a wide variety of woodland songbirds.

Wildlife Woody Cover Plantings¹

Woody cover plantings that can protect wildlife through the most severe winters consist of 10 or more rows of trees and shrubs, and are at least 200 feet wide and 600 feet long (3+ acres). Plantings may be rectangular, L-shaped or Arc-shaped, and in most cases, need not exceed 5 acres. In addition to the size requirements, plantings should include a shrub snow catch on the windward sides, four or more rows of evergreens and a shrub row or two on the leeward side (Table 1). Wherever possible, utilize the terrain to enhance the effectiveness of the planting, and use the planting to protect the food source and herbaceous cover from filling in with drifting snow.

Farmstead Shelterbelts¹

Although the primary function of shelterbelts is to protect humans and livestock from drifting snows and wind chill, if planned properly shelterbelts can also function as winter food/cover areas for wintering wildlife and reduce home heating costs by 33%. Where possible, shelterbelts should be L or Arc-shaped with the planting to the north and west of the farmstead. To increase the effectiveness and longevity of shelterbelts, it is critical that plantings have the following:

1. adequate width (200+ feet north to south and west to east) and length (600+ feet).

¹ For technical and perhaps financial assistance contact your local MNDNR Area Wildlife Manager and/or the USDA Natural Resources Conservation Service, and refer to Norrgard (1987) listed in the Information Resources section of this publication.

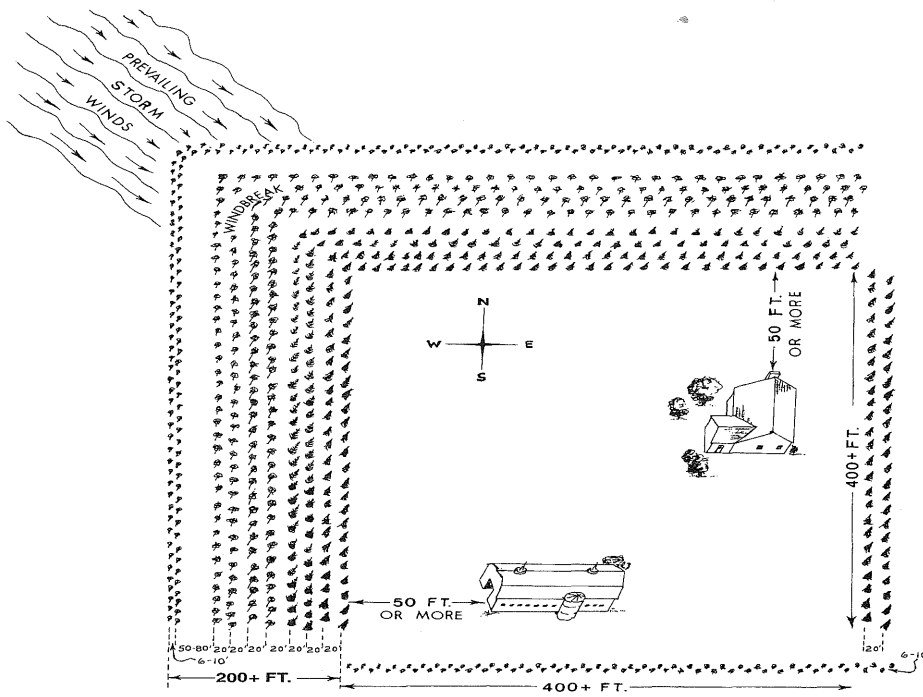

Figure 5. A farmstead shelterbelt design that effectively protects both the farmstead and wintering wildlife. For additional information on in-row and between-row spacing and desired species to plant, refer to Table 1. The supplemental shrub and/or evergreen plantings on the east and/or south edges of effective shelterbelts make the existing planting more effective in reducing snow drifting from the south and more attractive to wildlife. Be sure to keep any rows parallel to a driveway at least 50 feet away so that snowdrifts will not form on the driveway.

Table 1. The recommended between and in-row spacing for shrubs and trees in a well-designed shelterbelt and wildlife plantings. Row numbering begins with the outer most windward row (west or north edges) which is 1 and proceeds inward toward the most leeward row (Fig. 5).

ROW NUMBER	PLANT TYPE		DISTANCE TO NEXT PLANT IN ROW (IN FEET)	DISTANCE TO NEXT ROW (IN FEET)
	SHELTER BELT	WILDLIFE PLANTING		
1	Shrub	Shrub	3-6	6-10
2	Shrub	Shrub	3-6	50-80
3	Small Tree	Shrub	10-15, 3-6	20
4	Tall Tree	Evergreen	12-15	20
5	Tall Tree	Evergreen	15-20	20
6	Tall Tree	Evergreen	15-20	20
7	Evergreen	Evergreen	12-20	20
8	Evergreen	Evergreen	12-20	20
9	Evergreen	Evergreen	12-20	20
10	Evergreen	Shrub	12-20, 3-6	20, 6-10
11	Shrub	Shrub	3-6	10

Suggested species by plant type:

Shrubs = Freedom honeysuckle, red-osier dogwood, chokecherry, lilac, etc.

Small Trees = American plum, crab apples, Ginila maple, highbush cranberry, hawthorne, buffalo berry, etc.

Tall Tree =

Deciduous: green ash, hackberry, sugar maple, cottonwood, black walnut, etc. *Evergreens*: Austrian pine, ponderosa pine, etc.

Evergreens = Techney white cedar (rows 6, 7 or 8), Eastern red cedar, (rows 6, 7, 8 or 9), Black-hills spruce and Colorado blue spruce (row 6-10), etc.

2. a 50 to 100-foot snow drop area.
3. sufficient spacing within and between evergreen rows for trees to reach their optimum growth potential without shading the lower branches (Fig. 5, Table 1).

The core area of the shelterbelt (rows 4-10) should be comprised of long-lived species (>25 yrs, e.g., green ash, hackberry, Austrian and ponderosa pine, Techney white cedar, red cedar, Blackhills spruce) with a least rows 7-10 being evergreens (Table 1). One or two additional rows of evergreens and/or shrubs on the east and/or south boundaries of the farmstead sites, in conjunction with an adequate shelterbelt, enhance the attractiveness of the shelterbelt for wintering wildlife (Fig.5).

To greatly increase the attractiveness of any woody cover to a variety of wildlife, establish it immediately adjacent on the windward side of a 10+ acre patch of herbaceous cover (e.g., cattail, cane, switchgrass, native grasses). Also, young woody cover plantings can be made more attractive to birds requiring tree cavities by constructing nesting and shelter box substitutes (see Henderson 1987 and 1992).

INFORMATION RESOURCES

Henderson, C.L. 1987. Landscaping for wildlife. MN Department of Natural Resources, St. Paul. 144pp.

_____. 1992. Woodworking for wildlife MN Department of Natural Resources, St. Paul 111pp.

_____. 1995. Wild about birds: the DNR bird feeding guide. MN Department of Natural Resources, St. Paul. 278pp.

Norrgard, R. 1985. Woody cover plantings for wildlife. MN Department of Natural Resources, St. Paul. 16pp.

_____. 1987. Establishing and managing nesting cover for wildlife. MN Department of Natural Resources, St. Paul. 23pp.

APPENDIX A

Nesting and Brood Cover Requirements

In this booklet, we have outlined how to effectively provide the type and amount of winter habitat necessary to support sufficient numbers of breeding wildlife—particularly pheasants—to repopulate surrounding areas quickly after severe winters. Re-populating areas quickly and sustaining wild populations, however, requires adequate amounts of quality reproductive cover. Using the ring-necked pheasant as an indicator species, the following information should help you:

- 1) develop quality nesting and brood cover;
- 2) effectively utilize the landscape and cost-share programs; and
- 3) determine the amount of cover required to attain desired population levels.

Maximum pheasant densities are attained where:

1. There is one core wintering area per 2 square miles.
2. 50% of the landscape is in some form of grassland (e.g., undisturbed grassland, pastures, late-mowed hay, small grain crops) and the remainder in row crops.

As more land is converted to grasslands or to row crops, the carrying capacity of the landscape for pheasants declines (Fig. A1)

The best nesting cover consists of various combinations of perennial grass and forb species, provides residual cover 12 inches or more in height in the spring, and remains undisturbed until at least August 1.

Generally, undisturbed perennial nesting cover (UPNC) is categorized as introduced (exotic) cool season or native warm season. Usually cool season mixtures

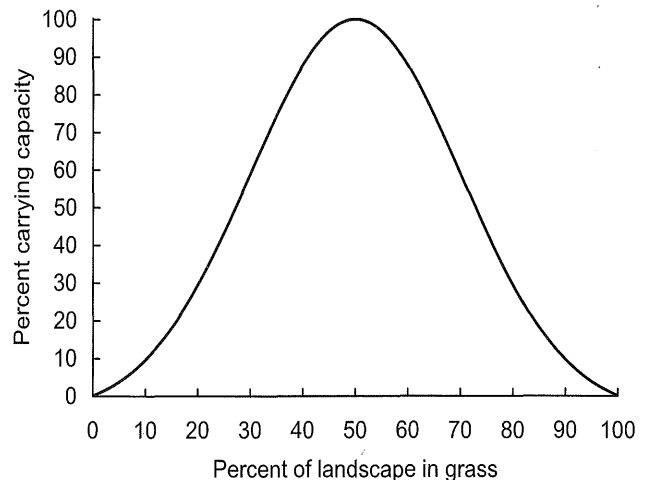

Figure A1. The relationship between the percent of the landscape in grasslands to the pheasant carrying capacity.

consist of 2-4 species of grasses and 1-3 species of legumes, while warm season mixtures consist of 4-7 species of grasses and 2 or more species of forbs (Table A1). Grasses provide the vertical and horizontal structure preferred by nesting hens, while forbs and legumes provide habitat for the insects so critical for chick food.

Hens will begin to lay eggs as soon as they are physiologically ready. Depending on weather conditions, nest establishment can begin as early as the second week of March, but usually no later than mid-April. If adequate UPNC is lacking, hens will randomly drop eggs or dump nest, reducing the hens' potential production. Hens will not establish nests unless residual cover or new growth is at least 10 inches high; in Minnesota, new growth reaches this height by about May 10 or a minimum of 3 weeks after hens are physiologically ready to nest.

The most cost-effective sites to develop new UPNC include parcels in the Conservation Reserve Program (CRP—both continuous and periodic enrollments), Conservation Reserve Enhancement Program (CREP), Wetland Reserve

Program (WRP), Reinvest in Minnesota Program (RIM), and roadsides.

In addition to UPNC, fields of small grains (e.g., oats, wheat), late-mowed hayfields (i.e., hayed once/year after July 1), and well-managed pastures (i.e., rest rotation) provide additional nesting and brooding areas. Small grains with an under seeding of legumes are particularly attractive to broods; insects are abundant and readily available, and the open structure at chick level allows easy mobility. On the other hand, the replacement of late-mowed hay with alfalfa significantly decreases the carrying capacity of the habitat. Although this cover type is very attractive to hens and broods, the early (late May and early June) and repeated mowing of alfalfa for hay destroys nests, nesting hens and hens with broods.

To sustain wild pheasant populations, the number of young recruited must match or exceed the number that die. Pheasant reproductive potential is quite high; one pair of birds can produce 10 chicks per year, yielding a 500% population increase. Actual population growth, however, is restricted by factors that limit reproduction and survival and seldom reaches 300%.

In general, populations will decline unless nest success averages at least 33%. Nest success is influenced by the amount, quality and shape of the nesting cover. Because predators can search narrow strips more effectively than large blocks of cover, pheasant nest success is lower in narrow strips. In habitats <66 feet wide, nest success decreases by about 1% for each foot of width removed from the strip cover (Fig. A2). Therefore, we recommend a minimum strip width of at least 66 feet for optimum pheasant nest success (the wider the better).¹

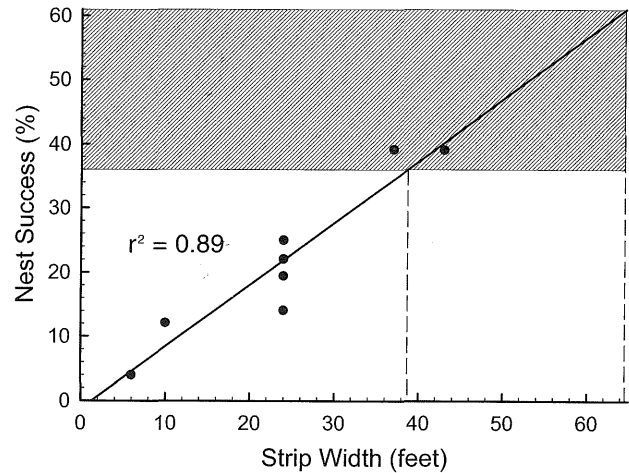

Figure A2. The relationship between width of strip nesting cover and pheasant nest success. The shaded area denotes the range of nest success observed in larger blocks of nesting cover (e.g., oats, undisturbed grass).

Both hen survival and chick recruitment are influenced by the amount of nesting cover available per hen in May. Generally, hen survival must average 70% from spring to fall and 43% from fall to spring to sustain the population. Furthermore, recruitment must average at least 3.3 chicks per May hen to replace the hens that will die. Both hen survival (Fig. A3) and chick recruitment (Fig. A4) fall below their respective thresholds when less than two acres of UPNC are available per May hen, especially if hens are in poor condition due to a severe winter or inadequate winter food/cover areas. However, both hen survival and chick recruitment reach a maximum with 3 acres of UPNC per May hen. Therefore, we recommend providing 3 acres of UPNC per May hen.

Hen density in May depends on winter survival, which in turn depends on the number of core wintering areas. One core winter area per 9 square miles can sustain a maximum of 200 hens through a severe winter, yielding 22 hens per square mile in

¹ Many other grassland birds suffer high predation rates when nesting within 150 feet of the grassland edge. Therefore, wide habitats are best.

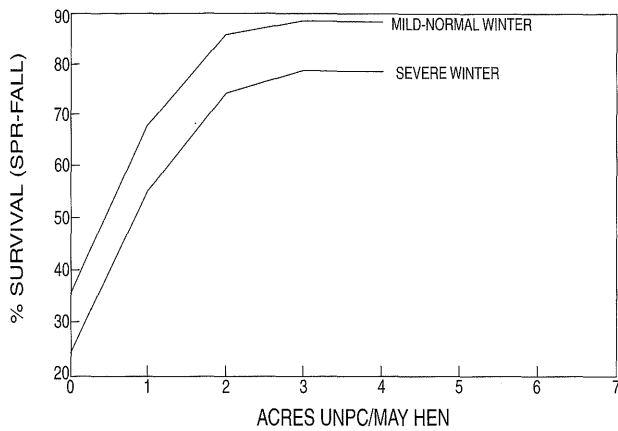

Figure A3. The effect of nesting habitat availability (undisturbed perennial nesting cover (UPNC)/May hen pheasant) on hen survival rate from spring to fall. If adequate winter habitat was available the previous winter, the mild-normal winter rates apply. Without adequate winter habitat, the severe winter rates are used.

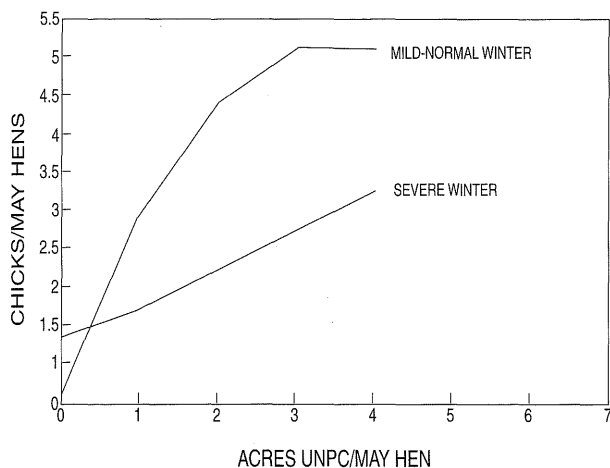

Figure A4. The effect of nesting habitat availability (undisturbed perennial nesting cover (UPNC)/May hen pheasant) on chick recruitment per May hen to the fall population. If adequate winter habitat was available the previous winter, the mild-normal winter rates apply. Without adequate winter habitat, the severe winter rates are used.

May. Therefore, 66 acres of UPNC per square mile would be required to maximize spring to fall hen survival and chick recruitment. The fall population resulting from this scenario would range from 65 to 205 pheasants per square mile (135±70). If higher average fall populations are desired, additional core areas and UPNC would have to be developed. For example, 2 core

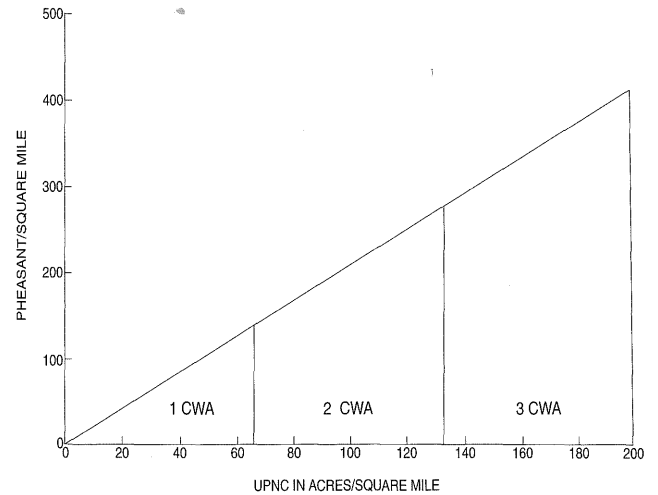

Figure A5. The combined effects of nesting habitat (acres of undisturbed perennial nesting cover (UPNC) per square mile) and winter habitat (number of core winter areas (CWAs) per nine square miles) on the density of ring-necked pheasants in the fall.

wintering areas per 9 square miles would be required to optimally utilize 132 acres of UPNC per square mile (resulting in 135 to 405 birds/Mi² (270±135), and 3 core areas for 198 acres of UPNC per square mile (resulting in 205 to 605 birds/Mi² (405±200) (Fig. A5 and Plate 3; inside back cover).

Pheasant populations are also influenced by the geographic distribution of reproductive and wintering habitats. In spring, hens leaving core wintering areas radiate out in all directions. About 54% of these hens travel less than 1 mile to nest and 86% less than 2 miles. Therefore, to increase the effectiveness of the UPNC, most of the cover should be within 1 mile of core wintering areas and should be available in all directions from the core areas. Grassland corridors (e.g., roadsides, filter strips) not only act as effective nesting cover but also serve to connect isolated blocks of cover within the surrounding sections (Plate 3; inside back cover).

Table A1. Recommended introduced and native seed mixtures for developing quality nesting and brooding cover for grassland birds.

Introduced Cool Season Mixture^a

Grasses:

Orchard Grass	3.0 lbs.
Tall Wheatgrass	2.0 lbs.
Timothy	1.0 lbs.

Legumes:

Red Clover	3.0 lbs.
Alsike Clover	2.0 lbs.

Native Warm Season Mixture

Grasses:

Big Blue Stem	1.5 lbs. ^b
Indian grass	1.0 lbs.
Switchgrass	0.5 lbs.
Little Blue Stem	0.5 lbs.
Green Needle Grass	1.0 lbs.
Canada Wild Rye	1.0 lbs.
Sideoats Gramma	0.5 lbs.

Forbs:

Various Asters, Golden Rods, Vervains, Coneflowers, Canada Milk Vetch, Ox-eye, and Black Eyed Susan, to name a few.

^a Avoid sod-forming grasses such as brome, fescue and reed canary, and legumes such as alfalfa and sweet clover.

^b Pounds are all expressed in pure live seeds per acre.

APPENDIX B:

Instructions for Constructing and Maintaining an Ear Corn Feeder Crib

Construction Details

Feeder cribs are very simple to construct. They consist of a 12-foot length of 39-inch woven wire fencing with six-inch stays formed into a 4-foot cylinder, which is stapled to a 4' x 4' wood platform. The platform is placed on old cement blocks, stones, fencepost legs, etc., to keep it about 10-18" off the ground (Fig. B1). With a diameter of four feet, this crib can hold about 20 bushels of ear corn, which is sufficient to feed 60 pheasants for 120 days and reduces the need for constant refills, unless there is deer use. Also, this design helps prevent the corn from being buried by snow and reduces the scattering of corn by wildlife. Remember: most farmland wildlife species are accustomed to finding their feed on the ground. Scattering some straw and corn around the base encourages use.

Filling the Crib

Cribs should be filled in the fall about the time farmers are harvesting their corn. It is important to fill the cribs before winter sets in so it is there for the wildlife to find after other food sources are eliminated by fall tillage. This will attract the wildlife to and retain them in the secure winter cover areas.

Points to Remember

1. **A managed food plot is the best way to provide a reliable food source.**
2. Feeder cribs are one way of placing a food source near an existing cover area where food is lacking. However, the greatest problems usually facing Minnesota wildlife are the loss of nesting cover (grasslands) and winter food/cover complexes.

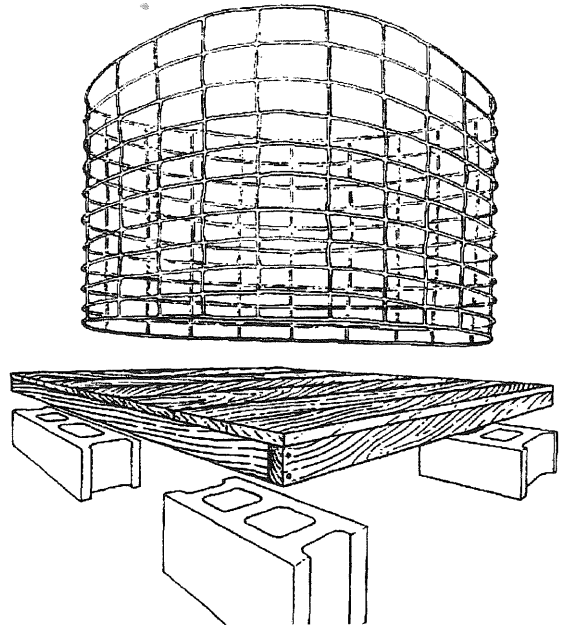

Figure B1. This feeder crib is designed to utilize ear corn as a food source for various wintering wildlife in Minnesota. The crib is designed to hold about 20 bushels of ear corn. (Materials needed: woven-wire fencing 39" high and 12' long with 6" stays, a 4' x 4' wood platform, 4 fencing staples, 4 cement blocks or 12"-posts, and a variety of nails.)

3. Place feeder cribs in open, windswept areas or areas well protected from drifting snow and adjacent to good cover such as a cattail or cane marsh or large (10+rows) shelterbelts containing a snow-catch and at least four rows of evergreens.
4. Fill feeder cribs with ear corn before winter and no later than November 15, and refill until snow melt; check the crib periodically to make sure that corn is available.
5. Deer also make use of feeder cribs and can consume a lot of corn and damage the crib. In such areas, the crib will require constant replenishment or a deer-proof enclosure (see Appendix Fig. D4), if food is to remain available to other small wildlife species.

APPENDIX C:

Instructions for Constructing a Shelled Corn Barrel Feeder for Deer

This simple barrel feeder (Fig. C1), with a capacity of about five bushels, can facilitate a feeding operation using either shelled corn or deer pellets. How the barrel is modified depends upon whether you have a sealed barrel with bungholes or a barrel with a separate lid. In either case you will need a cover for the top opening, a feeder plate to support the load of feed within the barrel and feeder holes cut into the side of the barrel. **Do not use barrels in which flammable materials like gasoline or other dangerous chemicals have been stored.**

1. Cut feeder holes into sides of the 55-gallon barrel. The lower edge should be $3\frac{1}{2}$ " above the bottom of the barrel. The holes should be $13\frac{1}{4}$ " wide and $7\frac{1}{4}$ " high. Three such holes should be cut $10\frac{1}{4}$ " apart.
2. Extend the vertical cuts that were made for the feeder holes upwards two extra inches to center of the expanded rim on the barrel. Then, fold in these tabs above each feeder hole. The tabs will hold the feeder plate in place.
3. Make the feeder plate. The procedure will vary depending on the type of barrels you are using.

A. If you have a barrel with a separate cover, save the cover and make the feeder plate out of green-treated plywood (5/8" minimum) and cut to the proper diameter. Make a feed spout from a 1-pound coffee can or an 8-inch length stove pipe (either 4" or 6" diameter). Cut down 2" from one end of the can (or pipe) to make tabs and bend tabs outward. Next, cut a hole to match the can (pipe) diameter in the

center of the feeder plate. A couple of screws should be used to secure the tabs to the feeder plate.

B. If you have a sealed barrel, cut out the top of the barrel and make the feeder plate as described above using the metal top. A top cover to keep out snow and rain can be made from whatever is handy. It will require some projections to fit either inside or outside the barrel to prevent the lid from being knocked off.

4. Make several $\frac{1}{4}$ " - $\frac{1}{2}$ " drain holes in the lowest points in the bottom of the barrel.
5. Force the feeder plate with spout down into the barrel to the bent-in tabs above the feeder holes.
6. Place the barrel on concrete blocks or some other type of platform to allow drainage and to keep it above the snow (Figs. B1 and D3).

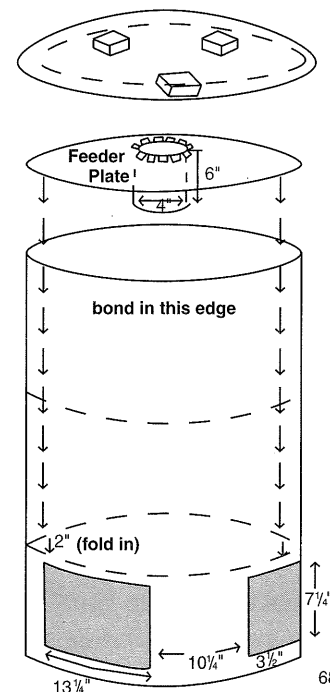

Figure C1. This barrel feeder, known as the "Olson Feeder" is designed to provide five bushels of shelled corn or feed pellets for wintering deer. By stacking another barrel on top, the volume can be increased to eight bushels.

APPENDIX D:

Instructions for Constructing a Shelled Corn Barrel Feeder for Upland Game Birds and Mammals

Both plastic or metal 55-gallon barrels can be used for this type of feeder (Fig. D1). However, when possible, get barrels that have removable lids and **do not use barrels in which flammable materials like gasoline or other dangerous chemicals have been stored.** Around the bottom of the barrel, cut three, 13½" x 8" rectangular openings about 10 inches apart and two inches above the bottom. Drill several half-inch holes in the lowest portion of the bottom to allow for drainage.

Construct a cone the diameter of the barrel (about 22") and about 8" high (Fig. D2). Place the cone with the high point projecting upward in the bottom of the barrel.

Place a 6' x 12-15" piece of ½" x 1" weld wire or ½" x ½" hardware cloth along the inside wall of the barrel so it covers the three openings around the bottom of the barrel. Drill ¼" holes in strategic locations to receive the ¼" bolts used to secure the wire mesh to the sides of the barrel. Bolt the fender washers on the inside to hold the wire in place.

Construct a platform that will allow for drainage and keep the barrel out of the snow (Fig. B1 or D3).

If you were unable to obtain barrels with removable lids, cut out the lid and fasten it to a piece of 24" x 24½"+ all weather plywood. The cut out portion attached will help keep the lid from sliding off.

SHELLED-CORN BARREL FEEDER FOR UPLAND GAME BIRDS AND MAMMALS

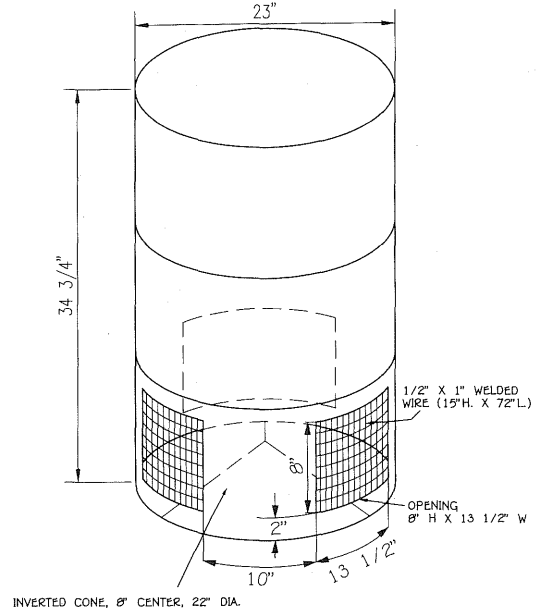

Figure D1. This barrel feeder is designed to provide about 5.3 bushels of shelled corn for various upland game birds and mammals. Information for constructing the inverted cone, platform, and deer-proof fence and the materials list are provided in Appendix D: Figs. D2, D3 and D5, and Table D1.

BARREL FEEDER CONE

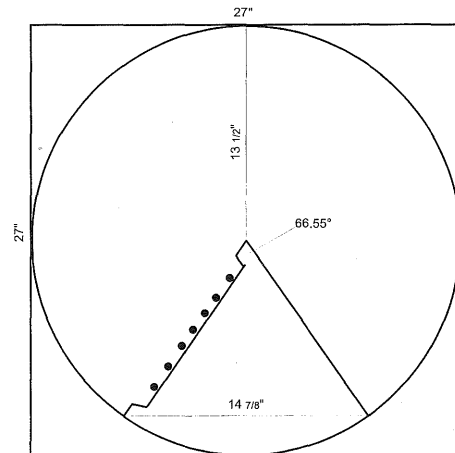

Figure D2. This cone is constructed of 26-gauge galvanized steel. Overlap the tab and pop rivet together. When complete, the cone will be about 8" high and 22" in diameter. Place the cone point up in the bottom of the barrel feeder (Appendix D: Fig. D1) to force the shelled corn outward against the ½" x 1" weld wire or ½" x ½" hardware cloth.

Table D1. The materials list is for constructing a deer-proof, shelled corn, wildlife barrel feeder for upland game birds and mammals.

ITEM	NUMBER REQUIRED
Barrel Feeder	
27" x 27," 26-ga. galv. Sheet metal	1
1/2" x 1" x 15"H x 6' L weld wire	1
55 gallon plastic or steel barrel	1
1/4" X 1/2" stove bolts w/nuts	12
1/4" fender washers	12
1/8" x 1/4" pop rivets	6
Platform	
1" x 8" x 8' green treated	3
2" x 4" x 8' green treated	1
2" x 4" x 12' green treated	1
4" x 4" x 6' green treated	1
3 1/2" galv. deck screws	32
2 1/2" galv. deck screws	40
Deer Enclosure	
7' T-posts	4
52"H x 16'L galv. cattle panels (4 ga.)	2
20' of 14 ga. fence wire ¹	1

¹This wire is used to fasten the cattle panels to the fence posts.

BARREL FEEDER PLATFORM

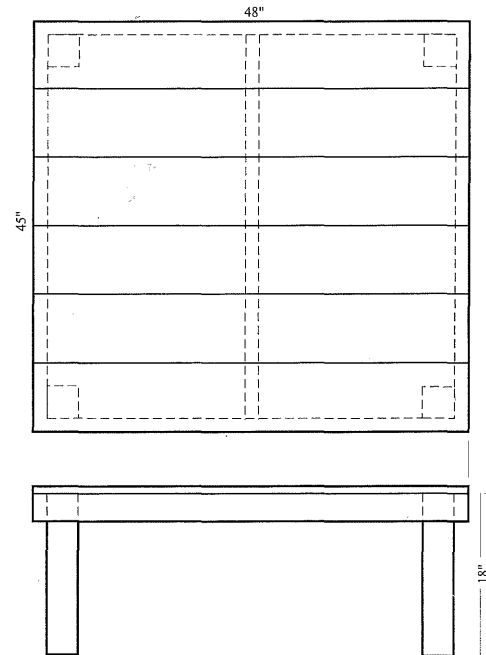

Figure D3. This platform is for the crib or barrel feeders shown in Figs. B1, C1 and D1. The materials required are listed in Table D1.

DEER EXCLOSURE

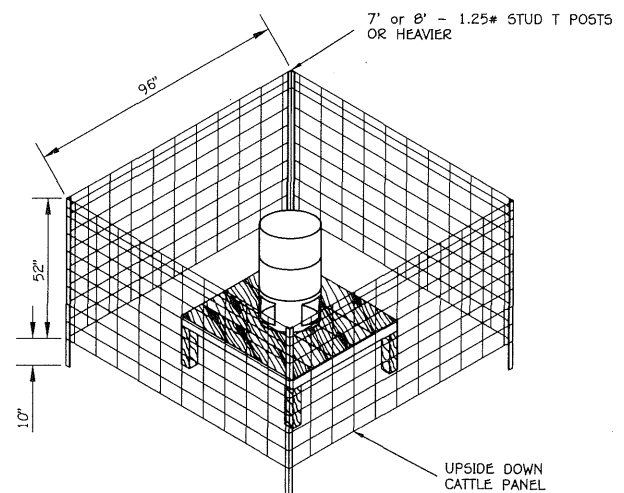

Figure D4. A fence designed to deny deer access to feeders designed to provide ear or shelled corn for upland game birds and mammals (See Appendix B: Fig. B1, Appendix D: Fig. D1). A materials list is provided in Appendix D: Table D1.

APPENDIX E:

How to Establish and Manage Switchgrass

The two switchgrass varieties Cave-in-Rock (Illinois variety) and Pathfinder (Nebraska variety) are specifically recommended for the herbaceous plot associated with core winter areas, because they provide tall, dense cover that is resistant to flattening by snow. Mixed stands of natives (e.g., big blue stem, Indian grass) do not stand up as well to snow, but are better than brome or reed canary, and require a specialized seeder (e.g., Truax).

Seeding and Establishment

Switchgrass seed is clean, free-flowing and can be seeded using a grain or grass drill or the broadcast method. A seeding rate of 4 to 6 pounds of **pure live seed** per acre is recommended. Successful seeding can be done from late April to mid-June; dormant (October-November) and frost seedings have also proven successful. Phosphorus and potassium should be applied according to soil tests before or at seeding. Nitrogen, however, should not be used because it will stimulate weed growth.

Cropped Sites: Because a firm seedbed is desired, drill seed directly into soybean stubble, if possible. If not, the prepared seedbed should be firmed with a roller or other suitable implement before drilling. Plant seeds 1/4 to 1/2 inch deep using a drill equipped with packer wheels for best results. For a successful broadcast seeding, the worked seedbed must be firmed with a roller before and after seeding.

Sod Sites: Switchgrass has been successfully interseeded into cool season grass sod. Intensively graze, mow or burn the grass area so that the remaining cover is not more than four inches high. Allow the area to green up before applying the herbicide. In the case of areas dominated by bluegrass, use a burndown

herbicide followed by a residual herbicide to slow the growth of the existing grass. Use a systemic herbicide rather than a burn down herbicide to control other cool season grasses (e.g., brome). After herbicide application is complete, interseed directly into the sod with a John Deere Interseeder or Truax No-till Seeder.

Management

Year 1: Controlling competition is essential in the establishment year, particularly on nutrient enriched soils. Mow at a 4-inch height in May, and if competition continues to be problem (which is usually the case), mow at 8-10-inch height in June and July. Do not allow the competition to get too high or when mowed the residual may smother out portions of the seeding. In rare situations (very dry seeding years), some mowing may also be required in year 2. Flail mowers (e.g., corn stalk chopper) are preferred because the finely chopped residue does not form an excessive mulch that may smother the switchgrass seedlings.

Year 5 and Beyond (Burning): Once the stand is established, do not disturb the stand for at least four years, except to control noxious plants (e.g., Canada thistle). In years 5 or 6 and about once every five years thereafter, burn the stand around mid-May. This will help maintain a vigorous stand and reduce competition from invading cool season grasses and noxious plants. For technical assistance on how to conduct prescribed burns and to develop a detailed burning plan, contact Minnesota's Department of Natural Resources (MNDNR) (Divisions of Wildlife or Forestry) or the U.S. Department of the Interior's Fish and Wildlife Service (USFWS) in your area. For assistance with the burning, contact your local fire department.

For additional information on establishing native warm season grasses such as switchgrass, contact your local U.S. Department of Agriculture Natural Resources Conservation Service, MNDNR (Wildlife), or USFWS personnel.

APPENDIX F:

How to Plant and Manage Forage Sorghum Wildlife Plantings

Site

Forage sorghum (sorghum-sudan varieties) does best on dry upland sites. If possible, locate the plantings south and east of existing cover such as trees or a marsh to keep blowing snow out of the plot (Fig. F2). If such cover does not exist, a 10+ acre planting with a corn snow-catch can stand on its own (Fig. F1). Such large plantings may also be useful in protecting high quality, existing cover of inadequate size (e.g., small conifer planting or wetland) (Fig. F3).

Size

A typical planting is ten acres. The forage sorghum is planted to provide eight acres of cover similar to a cattail marsh. The two acres of corn or grain sorghum provide the primary food sources as well as cover.

Planting Time

One of the most important requirements for a successful planting is a soil temperature of 65°F or more at planting time. In Minnesota, this is usually about May 20 to June 10. If planted too early, weeds and grasses will dominate the planting before the sorghum germinates. If planted too late, the sorghums/corn will not mature. It is usually best to plant the forage sorghum (cover portion) and the corn or grain sorghum (food portion) in separate plots.

Planting Rates

The forage sorghum is planted at a rate of 8-9 pounds of viable seed per acre. The corn is seeded at normal recommended rates and the grain sorghum is planted at 6-7 pounds of viable seed per acre. Sorghum and corn seed come in 50 pound sacks.

Plot Cleanup

Disk the plot very lightly or use a stalk chopper just enough to knock the stalks down. Then burn it. It will burn and clean up nicely if it has been knocked down first.

Recommended Varieties for Minnesota

Pioneer #931 and #988 will work well for the forage sorghum portion of the plot and Pioneer #894 for the grain sorghum. Any 80 to 100-day corn variety that has good standability will work well.

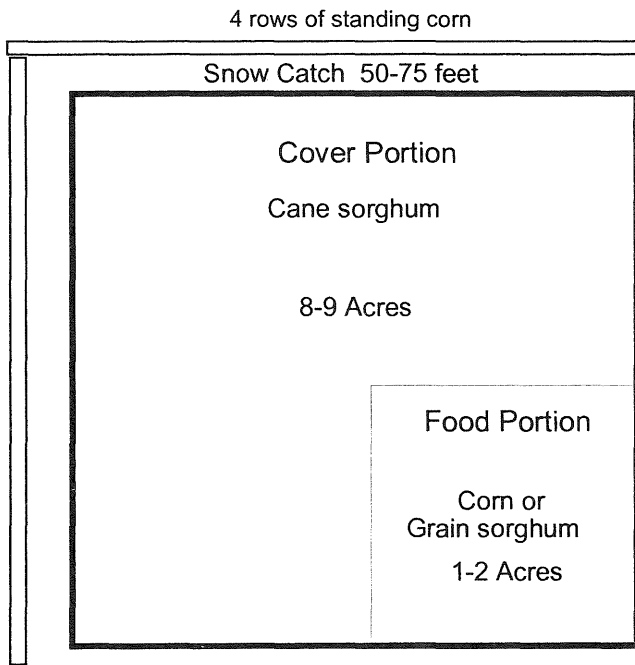

Figure F1. This plot is designed to stand alone as a food/cover complex.

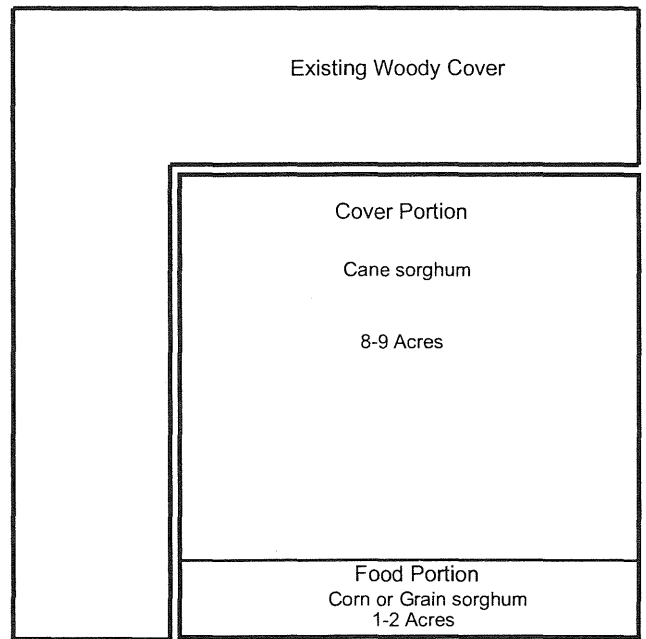

Figure F2. This plot is designed to take advantage of existing woody cover.

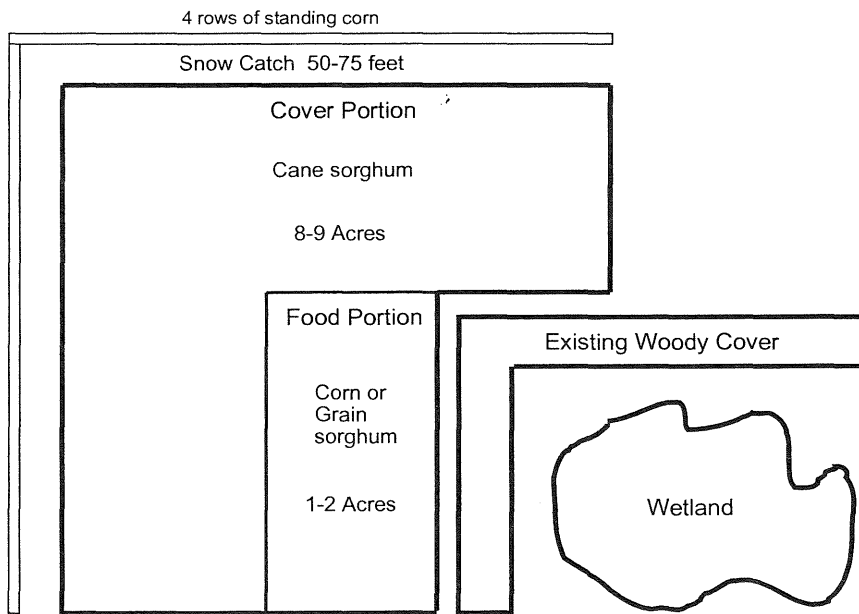
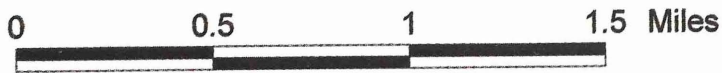
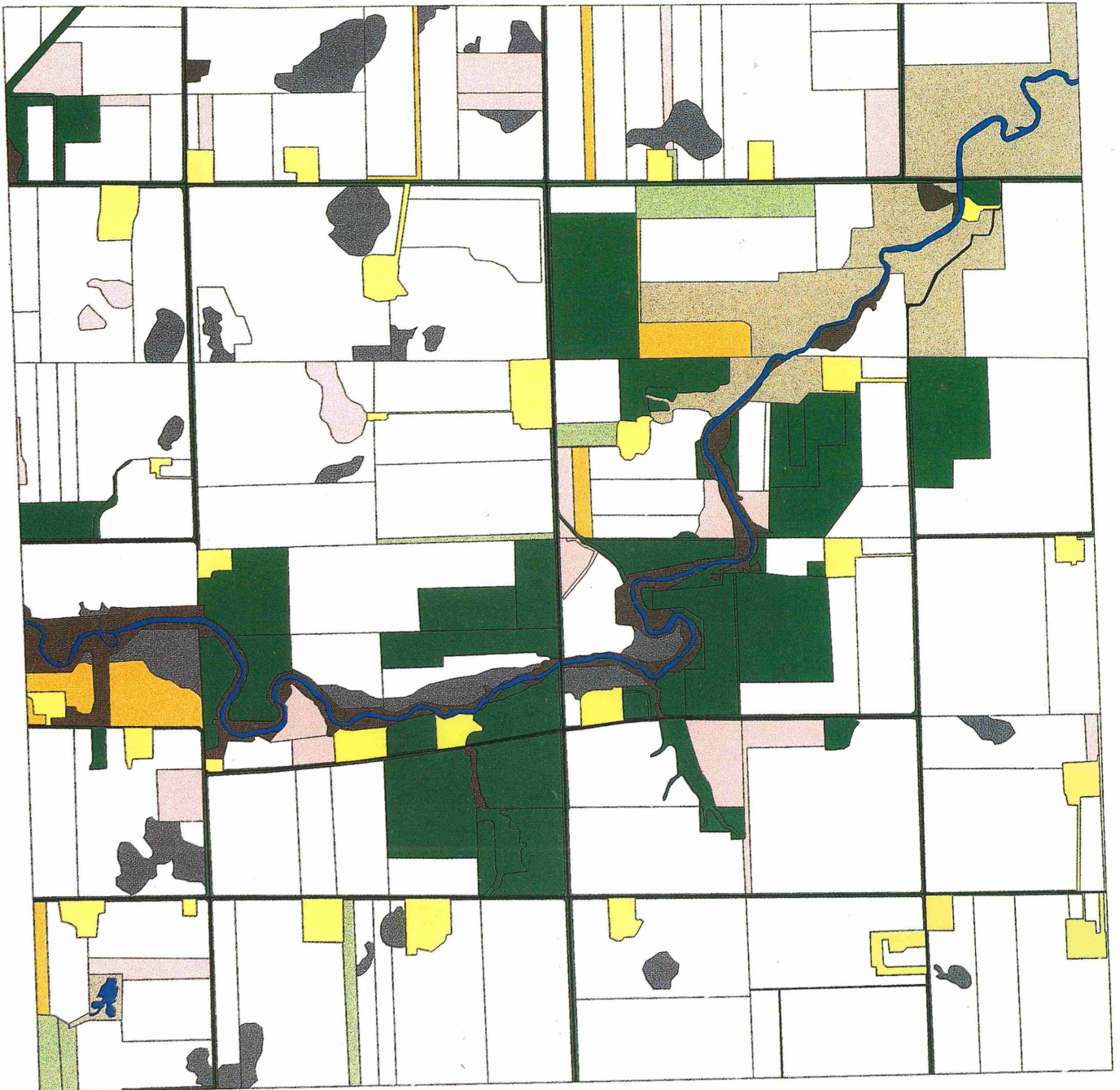

Figure F3. This plot is designed to provide food/cover complex while protecting existing woody and/or wetland cover.



- | | | |
|---|---|---|
|  Row Crops |  CRP/Grass |  Bare Ground |
|  Hay |  Wooded |  Road |
|  Small Grain |  Building Site |  Annual Set-aside |
|  Pasture |  Open Water | |

Plate 3. This 9-square mile area with about 10% in undisturbed perennial nesting cover and one winter core area is estimated to sustain an average fall population of between 65 and 205 135 ± 70 pheasants per square mile.

