

M.L. 2011 Project Abstract

For the Period Ending June 30, 2015

PROJECT TITLE: Minnesota Junior Master Naturalist Program

PROJECT MANAGER: Robert Blair

AFFILIATION: U of MN

MAILING ADDRESS: 135 Skok Hall, 2003 Upper Buford Circle

CITY/STATE/ZIP: St. Paul, MN 55108

PHONE: 651-644-1591

E-MAIL: blairrB@umn.edu

WEBSITE: www.minnesotamasternaturalist.org/juniornaturalist

FUNDING SOURCE: Environment and Natural Resources Trust Fund

LEGAL CITATION: M.L. 2011, First Special Session, Chp. 2, Art. 3, Sec. 2, Subd. 08b

APPROPRIATION AMOUNT: \$365,000

Overall Project Outcomes and Results

The Minnesota Master Naturalist Explorers program was created to address the problem that children are spending increasingly less time outside and, consequently, know less about their environment and world. It responded to the needs identified in the 2009 Outdoor Education Legislative Report to increase outdoor learning opportunities for children.

The program connected Master Naturalist volunteers with elementary youth in after-school programs to provide hands-on, outdoor activities. The volunteers were recruited by advertising on the Master Naturalist blog and website. Their training took place in 6-hour workshops that covered techniques for working with youth outdoors and in the use of the Explorers' curricula. The curricula are based on the phenology of fall, winter, and spring. Volunteers were provided with the curricula, nature journals, backpacks, pencils, and nametags. They also received supplemental materials to help implement the program including directions for locating a host site, lesson plan aids, and additional worksheets for youth participants. These materials are available at www.minnesotamasternaturalist.org/juniornaturalist

The Master Naturalist Explorers programs met for 4-8 weeks each, once a week. Each session lasted from one to two hours. Over the course of the program, 90 Master Naturalist volunteers were trained, 29 volunteers led programs at 33 sites across the state, and 482 youth participated.

Several pilot Explorers programs, which were focused on high-needs urban schools offering numerous after-school programs, were cancelled due to low enrollment. Subsequent enrollment efforts were more successful in schools that had less-developed after-school programs as well as at schools in rural portions of the state.

Many Master Naturalist volunteers who went through Explorers training did not lead multi-week Explorers programs, but reported using the knowledge and curriculum for other activities including church, Scout, and community education programs. Additionally, the volunteers were more likely to lead Explorers programs that were shorter in duration (e.g. 4 weeks).



Environment and Natural Resources Trust Fund (ENRTF) M.L. 2011 Work Plan Final Report

Date of Status Update: 6/30/2015

Final Report

Date of Work Plan Approval: 8/11/2011

Project Completion Date: 6/30/2015

Project Title: Minnesota Junior Master Naturalist Program

Project Manager: Robert Blair

Affiliation: U of MN

Address: 2003 Upper Buford Circle Suite 135

City: St Paul **State:** MN **Zipcode:** 55108

Telephone Number: (612) 624-2198

Email Address: blairrb@umn.edu

Web Address: <http://www.minnesotamasternaturalist.org>

Location:

Counties Impacted: Statewide

Ecological Section Impacted: Lake Agassiz Aspen Parklands (223N), Minnesota and Northeast Iowa Morainal (222M), North Central Glaciated Plains (251B), Northern Minnesota and Ontario Peatlands (212M), Northern Minnesota Drift and lake Plains (212N), Northern Superior Uplands (212L), Paleozoic Plateau (222L), Red River Valley (251A), Southern Superior Uplands (212J), Western Superior Uplands (212K)

Total ENRTF Project Budget:	ENRTF Appropriation \$:	365,000
	Amount Spent \$:	336,689
	Balance \$:	27,438

Legal Citation: M.L. 2011, First Special Session, Chp. 2, Art.3, Sec. 2, Subd. 08b
M.L. 2014, Chapter 226, Section 2, Subdivision 19

Appropriation Language:

\$365,000 the first year is from the trust fund to the Board of Regents of the University of Minnesota to expand the junior naturalist after-school programs. This appropriation is available until June 30, 2014, by which time the project must be completed and final products delivered.
Carryforward: The availability of the appropriations for the following projects are extended to June 30, 2015: (9) Laws 2011, First Special Session chapter 2, article 3, section 2, subdivision 8, paragraph (b), Minnesota Junior Master Naturalist Program;”

I. PROJECT TITLE: Minnesota Junior Master Naturalist: An After-School Program

II. FINAL PROJECT SUMMARY: Minnesota Junior Master Naturalist will pair current adult Minnesota Master Naturalist Volunteers with staff in existing after-school programs to offer fun, outdoor, science-based educational opportunities for 4th and 5th graders to learn about the ecology and natural history of their schoolyard, neighborhood, nearby natural areas, and the entire state.

The goals of the project are 1) to create a series of outdoor, sequential, science-based lessons with targeted learning outcomes that address the new MN K-12 Science Standards, 2) to prepare adult leaders to deliver these lessons in after-school programs for 4th and 5th graders with the aim of improving their performance on the 5th grade Science MCA exams and 3) to establish a permanent program to offer these lessons throughout Minnesota.

The lessons will focus on the physical changes in the seasons and their effects on plant and animal life. These lessons will be divided into three units -- Fall, Winter, Spring -- linked to *The Minnesota Weatherguide*. Each unit will include supplies for the volunteer to use while implementing the lessons. The pilot-testing and field-testing phases will be a collaborative effort between Master Naturalist staff, students, volunteer instructors, and after-school staff to develop lessons that are appropriate for teaching diverse audiences in schoolyard and park settings. Pilot-testing will occur at four sites including schools in St Paul, Minneapolis, and Willmar and the St Paul Parks Department. Field-testing will take place at 12 – 24 sites across the state. Final roll-out will include at least fifty locations in Minnesota.

III. PROJECT STATUS UPDATES

Project Status as of January 31, 2012:

The fall of 2011 work began with the Minnesota Master Naturalist Explorers program. In October, Darren Lochner was hired as coordinator of the Explorers program. Currently, Lochner and the Minnesota Master Naturalist team are working on developing Explorers lessons and youth education training materials for volunteers. In addition, site visits have been made to the pilot after-school programs to meet with staff and review structure of the individual programs. There has been an extensive review of after school programming and environmental education curriculum statewide and nationally.

The pilot-testing phase will be a collaborative effort between Master Naturalist staff, students, volunteer instructors, and after-school staff to develop lessons that are appropriate for teaching diverse audiences in schoolyard and park settings. Pilot testing will occur at four sites during the spring of 2012 including schools in St. Paul, Minneapolis, and Willmar and the St. Paul Parks and Recreation Department.

Please note that program name has been changed to Master Naturalist Explorers instead of Junior Master Naturalist to avoid confusion with DNR's Junior Park Naturalist Program run through Minnesota State Parks.

Project Status as of July 31, 2012:

During the spring of 2012 the Minnesota Master Naturalist Explorers program began pilot testing at two sites in St. Paul and Willmar. Each site paired a Master Naturalist volunteer with a staff member from the state program. The two after-school program sites provided an opportunity to test some of the Explorers lessons and learn more about after-school programming and youth environmental education. There were a total of 22 4th – 6th grade students involved with the spring sites. There were two additional sites in St. Paul and Minneapolis that did not host the Explorers program due to low enrollment of student participants.

This summer additional lessons are being developed for the fall and winter seasons. In addition, the program is planning on expanding to several new locations around the state during the pilot testing phase. These sites are being selected based on the availability of Master Naturalist volunteers and partner after-school programs. There will be six sites that will host the Explorers program during the fall of 2012. Other aspects of the Explorers program that continue to develop include a consistent and thorough process for volunteer background checks and photo release forms for student participants.

Project Status as of January 31, 2013:

During summer and fall of 2012 educational materials were developed for the fall and winter seasons. The educational materials consisted of: twelve lessons each for fall and winter, seasonal Explorers nature journal and extension activities to accompany the lessons. Three sites were planned for the fall 2012 pilot testing: St. Paul, Brooklyn Center and Hastings. As with the spring pilots, each of these locations paired a Master Naturalist volunteer with the after-school program. Due to low enrollment at each site, the pilots were cancelled. Follow up with the after-school program site coordinators revealed some of the following issues with low enrollment: competition with other after-school programming and ineffective marketing and promotion of the Explorers Program. Following the cancellation of these pilot sites the Explorers Program reached out to a network of teachers involved with citizen science and environmental education programs. Six teachers were recruited to assist with the Explorers Program for the winter and spring pilot sites. These teachers will be involved at their school with promoting the Explorers Program, overseeing the pilot, and providing evaluation of the educational materials and instruction by the Master Naturalist volunteers.

Project Status as of July 31, 2013:

The Explorers Program staff has continued to evaluate and revise the education materials to pair with the fall, winter and spring seasons. The educational materials consist of twelve lessons each and extension activities for the seasons along with an Explorers nature journal. The program incorporates nature journals and hands-on activities in the classroom and outdoors. The activities focus on learning about seasonal characteristics and changes (phenology) along with making observations outdoors related to weather, plants, animals and other natural features. In addition, a volunteer manual has also been developed for the program to serve as a resource for volunteers and staff. The manual provides an overview and information on the Explorers Program, tips and tricks for teaching youth outdoors, education principles, program guidelines and logistics and Frequently Asked Questions.

On June 1st, the Master Naturalist Explorers Program offered an advanced training on **Teaching Youth Outdoors**. The training focused on the Explorers Program and those individuals interested in working with youth in the outdoor classroom. Topics covered during the training included: importance and impact of getting youth outdoors, working with after-school programs and non-formal education programs, youth development and education, tips and tricks for teaching outdoors, and engaging youth in science based activities. There were 15 participants involved with the June advanced training. Another training is planned for the fall of 2013.

During the summer of 2013 the staff is working on obtaining full permission to use the education materials from the original authors. The education materials are being formally reviewed by a professional naturalist, K-12 teacher and Master Naturalist volunteer. The program is also working on expanding to additional sites during the fall.

Project Status as of January 31, 2014:

The fall of 2013 involved more Explorer programming at after-school sites. The Explorers Program continued to involve teacher partners that provided assistance with evaluating the program development and delivery. Three teacher partners were involved with the fall programs. To date we have had 9 Master Naturalist volunteers involved with the program and almost 150 youth participants at 12 sites.

The Explorers Program staff has continued to evaluate and revise the education materials to pair with the fall, winter and spring seasons. The focus for the fall season was to revise and update the winter education materials. Staff from the DNR assisted with designing a new nature journal with a new and improved layout including graphics and interactive nature related activities. The winter education materials are being used as a template for the updates to the spring and fall season journals.

On October 26th, the Master Naturalist Explorers Program offered another advanced training on **Teaching Youth Outdoors**. The training was held at Cedar Creek Reserve near Bethel, Minnesota. This ecological research site provided a quality environment for the fall training. The training focused on the Explorers Program and those individuals interested in working with youth in the outdoor classroom. Topics covered during the training included: importance and impact of getting youth outdoors, working with after-school programs and non-formal education programs, youth development and education, tips and tricks for teaching outdoors, and engaging youth in science based activities. There were 19 participants involved with the October advanced training. The training included several volunteers from the Fond du Lac Tribal community and other volunteers and educators that work with

Native American audiences. Additional partnerships are being pursued as a result of the training. Another training is planned for the spring of 2014.

During the fall of 2013 the staff obtained full permission to use the education materials from the original authors. The education materials were formally reviewed by a professional naturalist, K-12 teacher and Master Naturalist volunteer along with staff from the Master Naturalist Program. The review comments were used to revise and update the education materials. In addition, teacher partner suggestions were incorporated into the revised materials.

Amendment Request February 6, 2014

I am requesting a no-cost extension for this project until 6/30/2015 and a revision of the budget as detailed in Attachment A. As you may recall, the allocation of LCCMR funds was substantially delayed in 2011.

Timing: Our project was originally slated to take three years, starting 7/1/ 2011. The timeline that I proposed assumed that we would know about funding prior to 1 July and, consequently, be able to start the hiring process and have staffing in place at that date. Unfortunately, the timing of notification of the award precluded this and we did not have staff hired until late October 2011. This late start was then compounded by issues with being out-of-sync with the school year and led to a total delay in the project of approximately six months.

Budget: While implementing the project, we made two strategic decisions, which saved us money and should lead to better sustainability of the program after the end of the grant period:

1) We eliminated the need to provide \$200 of supplies to a volunteer to offer a session of the program. After interviewing teachers, volunteers, and after-school program coordinators, we decided to develop activities that required as few (and as inexpensive a set of) supplies and materials as possible. This decreased this expenditure in our budget from \$200 to \$20 per classroom per session. (And also eliminates the need to raise \$200 each time a session is taught at a school in the future.)

2) We greatly decreased the number of teachers hired to assist and evaluate the program. Instead we used the evaluation expertise of our new coordinator (Darren Lochner), a member of the Extension work team who does educational evaluation (Stephan Carlson), the DNR staff person associated with the project (Dawn Flinn), who had additional time devoted to the project provided by the DNR that was not in the original proposal. Additionally, several of our pilot-testing volunteers were retired teachers, who helped us immensely in two ways with the task – as volunteers and as professional teachers. These two changes have led to ~\$60,000 unspent in these two budget lines.

Finally, we have accomplished (or will have accomplished by May 2014), all of the activities and outcomes outlined below except Activity 3, Outcome 2. This Outcome is the one with the most impact for the project and one that we do not want to shot change. Outcome 2 is to reach 12 – 24 schools each season (Fall, Winter, Spring) at 50 different sites in the last year. To date, we have offered 12 sessions at 9 sites, and expect to expand this to 6 new sites this spring. Consequently, we need more time to accomplish this outcome and achieve full impact for the grant and project.

For these reasons, I am requesting a no-cost extension of this grant until 6/30/2015 and a reallocation of the budget to continue employment and travel for a staff person to insure wide spread dissemination of the materials and program that we have developed for an additional year.

Amendment Approved: May 9, 2014.

Project Status as of July 31, 2014:

The winter and spring of 2014 continued to see the Explorers Program grow. To date there have been 12 Master Naturalist volunteers involved with the 15 Explorer after-school programs and 240 youth participants. Of the 240 youth participants, 62% represented minority audiences.

Updates and revisions have continued with the education materials - nature journals and activities. All three seasons (winter, spring and fall) have been revised along with the Master Naturalist Explorers Volunteer Manual.

On March 7th, the Master Naturalist Explorers Program offered an advanced training on **Teaching Youth Outdoors**. The training was held at Fort Snelling State Park, Minnesota. The State Park site provided a quality environment for the fall training. On July 17th another advanced was held on **Teaching Youth Outdoors** at the Eastman Nature Center in Osseo, Minnesota. These trainings focused on the Explorers Program and those individuals interested in working with youth in the outdoor classroom. Topics covered during the training included: importance and impact of getting youth outdoors, working with after-school programs and non-formal education programs, youth development and education, tips and tricks for teaching outdoors, and engaging youth in science based activities. There were 17 participants involved with the March advanced training and 15 participants involved with the July. Additional trainings are planned the fall of 2014 and spring of 2015. A primary goal of these trainings is to increase the number of volunteers trained in the fundamentals of working with youth outdoors.

Project Status as of January 31, 2015:

The Explorers program refocused in fall 2014 with increased attention to strengthening school partnerships and program sustainability. Explorers programs were conducted at 4 schools and reached 53 students in grades 2-5. To date, 15 Master Naturalist volunteers and 293 students have been involved in the Explorers program. Of schools hosting an Explorers group in fall 2014, 2 were new sites and 2 built on previously-established relationships.

A new format for **Teaching Youth Outdoors** was offered on December 3rd and 4th at McColl Pond ELC in Savage, Minnesota. New volunteers attended training on both days which included examples of Explorers activities that would be conducted with youth, the importance and impact of getting youth outdoors, tips and tricks for teaching youth outdoors and writing lesson plans. In response to feedback that volunteers were uncertain about how to be involved in the Explorers program, Master Naturalist volunteers who had taken **Teaching Youth Outdoors** but not participated in the Explorers program were invited to attend the second day of training for additional content information on cultural competency, modeling the scientific process and updated information on how to participate in the Explorers program. Eleven Master Naturalist volunteers attended the training. An additional training is scheduled for February 25, 2015 at the University of Minnesota Cloquet Forestry Center.

Amendment Request August 12, 2105

I am requesting a revision of the budget as detailed in Attachment A. Specifically,

- 1) I want to shift \$10,002 of the salary for the program coordinator position to the program director position as the program coordinator position was unstaffed for approximately two months during a change in personnel. The duties of the coordinator were taken over by the director for this period. The shift in budget is an equal amount between the two positions.
- 2) I want to shift \$905 of the travel allowance for the program coordinator to teaching supplies which were purchased for additional workshops and additional Explorers classes offered in 2015. The shift in budget is an equal amount between travel and supplies.

Amendment Approved: August 13, 2015.

Overall Project Outcomes and Results

The Minnesota Master Naturalist Explorers program was created to address the problem that children are spending increasingly less time outside and, consequently, know less about their environment and world. It responded to the needs identified in the 2009 Outdoor Education Legislative Report to increase outdoor learning opportunities for children.

The program connected Master Naturalist volunteers with elementary youth in after-school programs to provide hands-on, outdoor activities. The volunteers were recruited by advertising on the Master Naturalist blog and website. Their training took place in 6-hour workshops that covered techniques for working with youth outdoors and in the use of the Explorers' curricula. The curricula are based on the phenology of fall, winter, and spring. Volunteers were provided with the curricula, nature journals, backpacks, pencils, and nametags. They also received supplemental materials to help implement the program including directions for locating a host site, lesson plan aids, and additional worksheets for youth participants. These materials are available at www.minnesotamasternaturalist.org/juniornaturalist

The Master Naturalist Explorers programs met for 4-8 weeks each, once a week. Each session lasted from one to two hours. Over the course of the program, 90 Master Naturalist volunteers were trained, 29 volunteers led programs at 33 sites across the state, and 482 youth participated.

Several pilot Explorers programs, which were focused on high-needs urban schools offering numerous after-school programs, were cancelled due to low enrollment. Subsequent enrollment efforts were more successful in schools that had less-developed after-school programs as well as at schools in rural portions of the state.

Many Master Naturalist volunteers who went through Explorers training did not lead multi-week Explorers programs, but reported using the knowledge and curriculum for other activities including church, Scout, and community education programs. Additionally, the volunteers were more likely to lead Explorers programs that were shorter in duration (e.g. 4 weeks).

IV. PROJECT ACTIVITIES AND OUTCOMES:

ACTIVITY 1: Develop and Pilot-test Fall, Winter & Spring Curricula

Description: We will develop and pilot-test a series of weekly lessons on the physical changes in the seasons and their effects on plant and animal life. These lessons will be divided into three units linked to *The Minnesota Weatherguide*, a natural history calendar. Each seasonal unit (Fall, Winter, Spring) will include supplies for the volunteer to use while implementing the lessons. The pilot-testing phase will be a collaborative effort between Master Naturalist staff, students, volunteer instructors, and after-school staff to develop lessons that are appropriate for teaching diverse audiences in schoolyard settings. We will then evaluate and revise the units.

Summary Budget Information for Activity 1:

ENRTF Budget: \$ 95,180
Amount Spent: \$ 95,116
Balance: \$ 14

Activity Completion Date:

Outcome	Completion Date	Budget
1. <i>Develop, pilot test at 4 sites, and revise curricula.</i>	12-31-14	\$95,180

Activity Status as of January 1, 2012: The Spring seasonal unit is under development and will be pilot tested starting in mid-March. Master Naturalist volunteers and staff will be involved with teaching and evaluating the lessons.

Activity Status as of July 31, 2012: The spring 2012 seasonal unit was evaluated by Master Naturalist volunteers and program staff. This summer additional lessons are being developed for the fall and winter seasons. Each unit will have seasonal lessons associated with an overall theme. The lessons developed for the fall unit will be tested beginning in September.

Activity Status as of January 31, 2013: Educational materials were developed for the fall and winter seasons. The educational materials consisted of: ten to twelve lessons each for fall and winter, seasonal Explorers nature journal and extension activities to accompany the lessons. The educational materials have been shared with Master Naturalist volunteers and environmental educators for review.

Activity Status as of July 31, 2013

During the summer of 2013 the staff is working on obtaining full permission to use the education materials from the original authors. The permission to use the education material will allow the Explorers Program to freely share and distribute the material upon completion of the program. The education materials are being formally reviewed by a professional naturalist, K-12 teacher and Master Naturalist volunteer. The comments received from the reviewers will result in a revision of the materials. **Activity 1 was completed as of July 31, 2013.**

Activity Status as of January 31, 2014

The Explorers Program staff has continued to evaluate and revise the education materials to pair with the fall, winter and spring seasons. The focus for the fall season was to revise and update the winter education materials. Staff from the DNR assisted with designing a new winter nature journal with graphics and interactive nature

related activities. The winter education materials are being used as a template for the updates to the spring and fall seasons.

During the fall of 2013 the staff obtained full permission to use the education materials from the original authors. The education materials were formally reviewed by a professional naturalist, K-12 teacher and Master Naturalist volunteer along with staff from the Master Naturalist Program. The review comments were used to revise and update the education materials. Based on comments from the reviewers the formatting and content for winter activities was improved upon.

Activity Status as of July 31, 2014

Updates and revisions have continued with the education materials - nature journals and activities. All three seasons (winter, spring and fall) have been revised along with the Master Naturalist Explorers Volunteer Manual. The manual is a guide for volunteers involved with the Explorers after-school programming.

Project Status as of January 31, 2015:

The Explorers nature journals, activity guides and volunteer manual have all been modified to align with organizational standards as part of the University of Minnesota’s branding initiative.

Final Report Summary:

Master Naturalist Explorers activity guides and nature journals were created for each season, fall, winter, and spring. The activity guides provide volunteers with hands-on lessons that require little set-up and few materials. Based on the phenology of seasonal changes, lessons focus on observing and understanding the natural world. Explorers nature journals provide space for youth participants to record data, observations, and write about their experiences.

Master Naturalist Explorers activity guides, nature journals, and other resources are completed and available for free on the Master Naturalist website, www.minnesotamasternaturalist.org/explorers. The website utilizes much of the information in the volunteer manual but provides readers with the opportunity to read source materials in their entirety.

ACTIVITY 2: Train Master Naturalist Volunteers & Field-test Curricula

Description: While developing sequenced curricula is vital, it is also important to develop and evaluate training materials for the volunteer instructors i.e. field-testing. Field-testing will be done the second year to insure that the developed materials and adult training materials are appropriate for widespread implementation. In Yr. 2, we will train 16 – 24 additional Master Naturalist Volunteers who want to work with the Jr. Program. They will then test the materials at eight additional sites for at least one season (for a total of 12 sites over the school year) followed by evaluation and revision of both the lessons and training materials. Some sites may participate all three seasons while some sites may choose to participate for only one or two seasons during the school year. Additional sites will increase the geographic coverage.

Summary Budget Information for Activity 2:

ENRTF Budget: \$ 100,963
Amount Spent: \$ 100,104
Balance: \$ 859

Activity Completion Date:

Outcome	Completion Date	Budget
<i>1. Develop and Implement Training for 16 – 24 Master Naturalist Volunteer Instructors</i>	9-30-12	\$600
<i>2. Field Test Curricula at 4 - 12 Sites then Revise for Final Distribution.</i>	12-31-13	\$100,363

Activity Status as of January 31, 2012: The training of volunteers and field testing of the curricula will begin with the pilot testing of the Explorers Program during the spring 2012 season.

Activity Status as of July 31, 2012: The two pilot sites during the spring 2012 season provided an initial opportunity to evaluate the Explorers lesson content and delivery. The volunteers involved with the spring programming received one-on-one training from the Master Naturalist staff. The field-testing of the seasonal curricula will continue during the upcoming fall and winter seasonal units. There will be twelve volunteers trained for the fall unit.

Activity Status as of January 31, 2013: The volunteers that were recruited to lead the fall pilot sites did receive one-on-one training and draft training manual from Master Naturalist staff. Even though the fall pilot sites were cancelled due to low enrollment, the volunteers did provide feedback on the education materials and suggestions on training needs for future programming.

Activity Status as of July 31, 2013: On June 1st, the Master Naturalist Explorers Program offered an advanced training on **Teaching Youth Outdoors**. The training focused on the Explorers Program and those individuals interested in working with youth in the outdoor classroom. Topics covered during the training included: importance and impact of getting youth outdoors, working with after-school programs and non-formal education programs, youth development and education, tips and tricks for teaching outdoors, and engaging youth in science based activities. There were 15 participants involved with the June advanced training. Another training is planned for the fall of 2013. **Activity 2 Outcome 1 was completed June 1, 2013**

Activity Status as of January 31, 2014

On October 26th, the Master Naturalist Explorers Program offered another advanced training on **Teaching Youth Outdoors**. The training was held at Cedar Creek Reserve near Bethel, Minnesota. This ecological research site provided a quality environment for the fall training. The training focused on the Explorers Program and those individuals interested in working with youth in the outdoor classroom. Topics covered during the training included: importance and impact of getting youth outdoors, working with after-school programs and non-formal education programs, youth development and education, tips and tricks for teaching outdoors, and engaging youth in science based activities. There were 19 participants involved with the October advanced training. The training included several volunteers from the Fond du Lac Tribal community and other volunteers that work with Native American audiences. Additional partnerships are being pursued as a result of the training. Another training is planned for the March 7, 2014. The field-testing in Activity 1 Outcome 2 was completed 1 June 2013. Final revision for Winter materials was completed 1 January 2013. Final Revision for Spring materials will be completed by February 15 2014. Final Revision for Fall materials will be completed by April 15, 2014. **Consequently, Activity 2 Outcome 2 is expected to be completed by June 1, 2014.**

Activity Status as of July 31, 2014

Final revisions for the Spring and Fall education materials were completed. **Activity 2 was completed as of June 1, 2014.**

Project Status as of January 31, 2015: Completed.

Final Report Summary:

In the winter and spring of 2015, 18 additional Master Naturalists completed Explorers Training. The training in Rochester was scheduled based on volunteer requests to have a session in southeastern Minnesota. Although fewer Master Naturalists registered for later workshops titled "Master Naturalist Explorers Training" than the same class titled "Teaching Youth Outdoors," we found more individuals led or planned Explorers programs when the workshop title was more specific.

To date, 90 Master Naturalists have participated in Explorers Training. Volunteers are concentrated in the metro area, but have also come from Duluth, Cloquet, Brainerd and Rochester.

ACTIVITY 3: Expand Program to 50 Sites Statewide.

Description: In the final year of the grant, we will train at least 50 additional Master Naturalist Volunteers and offer the field-tested Junior Master Naturalist program in at least 50 after-school programs statewide for at least one season at each site. Sites may choose to participate for one, two, or all three seasons.

Summary Budget Information for Activity 3:

ENRTF Budget: \$ 168,857
Amount Spent: \$ 141,419

Activity Completion Date:

Outcome	Completion Date	Budget
1. Train 50 additional Master Naturalist Volunteers	12-30-14	\$2,500
2. Offer Seasonal Curricula at 12 – 24 Sites each season for a total of 50 unique sites overall.	6-30-15	\$166,357

Activity Status as of January 31, 2012: The plan is to partner with four after-school sites during the spring of 2012 for field-testing of the Explorers Program.

Activity Status as of July 31, 2012: During the spring of 2012 the Minnesota Master Naturalist Explorers program began pilot testing at two sites in St. Paul and Willmar. Each site paired a Master Naturalist volunteer with a staff member from the state program. The program will be expanded to several new locations around the state during the fall of 2012. These sites are being selected based on the availability of Master Naturalist volunteers and partner after-school programs. There will be six sites that will host the Explorers program during the fall of 2012.

Activity Status as of January 31, 2013: Following the cancellation of these pilot sites the Explorers Program reached out to a network of teachers involved with citizen science and environmental education programs. Six teachers were recruited to assist with the Explorers Program for the winter and spring pilot sites. Three pilot sites are planned for the winter season and six sites are planned for spring of 2013. The Bell Museum of Natural History at the University of Minnesota will be involved with future training of Master Naturalist volunteers.

Activity Status as of July 31, 2013

The winter and spring of 2013 involved more pilot testing at after-school sites. Three of the programs involved teacher partners that provided assistance with evaluating the Explorers Program development and delivery. To date we have had eight Master Naturalist volunteers involved with the program and 74 youth participants. The goal is to have 12 after-school programs participating during the fall of 2013.

Activity Status as of January 31, 2014

The fall of 2013 involved five Explorer Programs at after-school sites. The Explorers Program continued to involve teacher partners that provided assistance with evaluating the program development and delivery. To date we have had 9 Master Naturalist volunteers involved with the program and almost 150 youth participants at 12 sites. A majority of Explorer Program sites have been diverse with approximately 60% of the student participants representing minority audiences.

Activity Status as of July 31, 2014

As of July 17, 2014 there have been a total of 66 adults trained as part of the Master Naturalist Explorers advanced training, Teaching Youth Outdoors. To date there has been 12 Master Naturalist volunteers involved with the 15 Explorer after-school programs at 11 unique sites. A total of 240 youth participants have been involved with the Explorers after-school program. Of the 240 youth participants, 62% have represented minority audiences.

Additional advanced trainings are planned the fall of 2014 and spring of 2015. A primary goal of these trainings is to increase the number of volunteers trained in the fundamentals of working with youth outdoors. The objectives of the final year of the grant is to broaden the geographic scope of the offerings and to formalize the model that will be used to disseminate the materials and training after the end of the grant period.

Project Status as of January 31, 2015:

As of January 31, 2015 there have been 72 adults trained as part of the Master Naturalist Explorers advanced training, Teaching Youth Outdoors. 15 Master Naturalist volunteers have led 20 Explorers programs at 14 unique sites, allowing both to maintain relationships with previous program participants as well as expand programming throughout the state of Minnesota. A total of 293 students have been involved in the Explorers program. There are six new confirmed sites for winter and spring programming with 5 new Master Naturalist volunteers.

Additionally, a total of 83 adults have participated in the Master Naturalist Explorers advanced training-- Teaching Youth Outdoors. While many have not led a full Explorers program through the Master Naturalist program, they report using the material in other community settings including community education, scout groups, and churches. Finding that volunteers use material out of the original intended context was an unexpected outcome that we plan to investigate further through a formal evaluation in the coming months. This will allow us to quantify the overall impact of the Explorers program on Minnesota's youth. Teaching Youth Outdoors will be offered again February 25, 2015

Final Report Summary:

During the winter and spring seasons of 2015, 20 Master Naturalist volunteers led Explorers programs at 13 sites. New partnerships were established with the Minnesota Valley National Wildlife Refuge and after school care programs, while partnerships with community education and Targeted Services programs were maintained. Instead of focusing recruitment efforts on academic school programs that were often cancelled for low enrollment, we worked with groups that already had youth participants gathered after school, such as the St. Paul YWCA Young Achievers Program and after school care programs. This resulted in fewer cancelled offerings as well as increased participant diversity. Ten of the 13 Explorers programs were held at new host sites. Fourteen of the twenty volunteers in the 2015 winter and spring sessions had not led an Explorers program previously. Although the Explorers program was not held at 50 unique sites in its final year, it grew and attracted new audiences. In winter and spring 2015, 189 students attended Explorers programs. Across the duration of the grant, 482 youth participants attended Explorers programs at 33 sites across the state led by 29 volunteers. The volunteers that attended Explorer training but did not teach full 4-8 week Explorer courses reported using both the materials and techniques in other settings,

V. DISSEMINATION:

Description: This project is a dissemination project. The major outcome will be the development and testing of the curricula with a delivery mechanism provided by Minnesota Master Naturalist volunteers. Depending on resources and abilities, we may develop a separate web section for youth on the Master Naturalist web site, though this is not included as an outcome of this proposal. However, the final curricula will be available in digital format, free of charge, from the Minnesota Master Naturalist program to any interested party.

After the grant ends, the longevity of the program being offered through Minnesota Master Naturalist will depend on hiring a permanent coordinator and finding funds to provide supplies to the Master Naturalist Volunteers and after-school programs. Currently, the Master Naturalist program is growing a long-term donor base, which may be sufficient to provide for these needs. Alternatively, we may need to seek other grants to guarantee the baseline funding. We understand that this grant is one-time funding for this project from the LCCMR; however, we hope this will not preclude us from applying for new initiatives that develop with Minnesota Master Naturalist.

Status as of January 31, 2012:

No dissemination occurred.

Status as of July 31, 2012

Pilot testing occurred at two sites in St. Paul and Willmar with a total of 22 4th – 6th grade students.

Status as of January 31, 2013

Three sites were planned for the fall 2012 pilot testing: St. Paul, Brooklyn Center and Hastings but all were cancelled due to low enrollment.

Status as of July 31, 2013

The winter and spring of 2013 involved more pilot testing at after-school sites. Three of the programs involved teacher partners that provided assistance with evaluating the Explorers Program development and delivery. To date we have had eight Master Naturalist volunteers involved with the program and 74 youth participants. On June 1st, the Master Naturalist Explorers Program offered an advanced training for 15 adults *on Teaching Youth Outdoors*.

Status as of January 31, 2014

The Explorers Program continued to involve teacher partners that provided assistance with evaluating the program development and delivery. Three teacher partners were involved with the fall programs. To date we

have had 9 Master Naturalist volunteers involved with the program and almost 150 youth participants at 12 sites. On October 26th, the Master Naturalist Explorers Program offered another advanced training on Teaching Youth Outdoors to 19 participants including several members of the Fond du Lac tribal community.

Status as of July 31, 2014

The winter and spring of 2014 continued to see the Explorers Program grow. To date there have been 12 Master Naturalist volunteers involved with the 15 Explorer after-school programs and 240 youth participants. Of the 240 youth participants, 62% represented minority audiences. On March 7th, the Master Naturalist Explorers Program offered an advanced training for on *Teaching Youth Outdoors* at Fort Snelling State Park, Minnesota for 17 participants. On July 17th another advanced was held on *Teaching Youth Outdoors* at the Eastman Nature Center in Osseo, Minnesota with an additional 15 participants.

Status as of January 31, 2015

Explorers programs were conducted at 4 schools and reached 53 students in grades 2-5. To date, 15 Master Naturalist volunteers and 293 youth participants have been involved in offering 20 Explorers program. An additional 11 volunteers were trained in December 2014 and future trainings are planned in Cloquet, Brainerd, and Rochester to reach audiences outside of the metro area. Additionally, a total of **83** adults have participated in the Master Naturalist Explorers advanced training-- Teaching Youth Outdoors. While many have not led a full Explorers program through the Master Naturalist program, they report using the material in other community settings including community education, scout groups, and churches.

Final Report Summary:

At the conclusion of the Master Naturalist Explorers program, 90 adult Master Naturalists participated in workshops on teaching outdoors, 33 Explorers programs were held at 24 unique sites, and 29 Master Naturalist volunteers led 482 youth participants in grades 1-5 in outdoor activities.

Program materials including activity guides, nature journals, and resources for leading outdoor youth programs are available on the Master Naturalist website, www.minnesotamasternaturalist.org/explorers, for all Minnesotans to access. They are also included in the recommended resources for Minnesota Project Get Outdoors.

VI. PROJECT BUDGET SUMMARY:

A. ENRTF Budget:

Budget Category	\$ Amount	Explanation
Personnel:	258,298	\$34,638 total for Rob Blair, UMN, 1 month salary per year for three years, 33.3% fringe benefits, to assist in development of curricula, serve as a liaison between the Minnesota Master Naturalist (adult) program and Minnesota Junior Master Naturalist) and manage project throughout year. \$223,660-total for coordinator, 12 months salary for <u>three years and nine months</u> , 33.3% fringe benefits to develop, adapt, evaluate, refine curriculum and implement program.
Equipment/Tools/Supplies:	\$ 7,025	For seasonal supplies for each school/program participating in Junior Master Naturalist, up to three seasons per year (Fall, Winter, Spring), \$20 of supplies per school per season; 4 schools Yr 1, 12 schools Yr 2, 50 schools Yrs 3 and 4.
Printing:	\$ 750	\$750 for printing of pilot-test materials and evaluations, \$250 per year.
Travel Expenses in MN:	\$ 3,848	Travel for staff to visit schools to evaluate implementation and to conduct training: 1173 miles Year 1, 2000 miles Year 2, 4000 miles Years 3 and 4

Other:	\$ 95,079	<p>\$1,100 salary supplement for staff teachers involved in pilot- and field-testing.</p> <p>\$3,500 for workshops to train volunteers including room rental, printing of training materials, teaching supplies, recognition pins, name badges, and background checks. Estimate based on \$50 per volunteer.</p> <p>\$4,900 in unallocated funds.</p> <p><i>Contract to DNR</i> \$74,580 salary for DNR staff member, 25% time for three years, 37.2% fringe benefits, to adapt and develop curricula and to guide coordinator; \$11,000 for graphic design and printing of final materials including promotional materials (brochures, banners, pins, badges) in Year 1, seasonal curricula for students Year 2, training materials for instructors Year 3.</p>
TOTAL ENRTF BUDGET:	\$365,000	

Explanation of Use of Classified Staff:

Explanation of Capital Expenditures Greater Than \$3,500: None.

Number of Full-time Equivalent (FTE) funded with this ENRTF appropriation: 1.11

Number of Full-time Equivalent (FTE) estimated to be funded through contracts with this ENRTF appropriation: 0.25 at DNR

B. Other Funds:

Source of Funds	\$ Amount Proposed	\$ Amount Spent	Use of Other Funds
Non-state			
National Science Foundation	\$2,700,000	\$	This proposal is under consideration for funding at NSF to broaden the Master Naturalist program: one portion involves evaluating the Jr. Master Naturalist and extending it two more years.
VISTA	\$108,000	\$	VISTA will provide one worker for up to three years on this project. The first year of funding (~\$36,000) has been secured.
State			
	\$44,000	\$0	This is the approximate value of personnel hours and fringe devoted by Extension staff on the project (25% of an FTE annually)
TOTAL OTHER FUNDS:	\$2,852,000	\$0	

VII. PROJECT STRATEGY:

A. Project Partners: The main partners in this project are Univ. of MN Extension and the MN Dept. of Natural Resources, which jointly run the MN Master Naturalist Program. Rob Blair (Assoc. Professor; Fisheries, Wildlife and Conservation Biology; UMN-St. Paul), Amy Rager (UMN Extension – Morris), Nate Meyer (UMN Extension – Cloquet), Andrea Strauss (UMN Extension – Rochester), John Loegering (Assoc. Professor – UMN Crookston), Karen Oberhauser (Assoc. Professor, UMN St. Paul), and Dawn Flinn (Education Coordinator – MN DNR) all participate in the operation of the Minnesota Master Naturalist program. Each Master Naturalist staff member will devote at least two weeks of their time to this new project in addition to staff hired with the LCCMR funds. The University of Minnesota will receive a total of \$365,000 and will distribute \$85,580 of this to the DNR in a subaward.

Minnesota Master Naturalist is a joint program of University of Minnesota Extension and Minnesota Department of Natural Resources. The program has been operating for five years with a Collaboration Agreement between the two entities and it delineates both responsibilities and expectations. The agreement designates University of Minnesota Extension as the fiscal agent and the Regents of the University of Minnesota as the copyright holder of all materials produced in the program.

Minnesota Junior Master Naturalist will be a new venture of the Minnesota Master Naturalist program. The newly hired coordinator of Jr. Master Naturalist will be an employee of University of Minnesota Extension and will be directly supervised by Robert Blair at the University of Minnesota. A DNR staff member involved with education, will support Dr. Blair in supervising the new Junior Master Naturalist Coordinator. Both the DNR staff member and the new coordinator will be responsible for adapting, refining, and evaluating the curriculum for the Jr. Master Naturalist program. Consequently, they will work closely to insure that the program meets the objectives of both agencies. The new coordinator will devote 100% of his or her time to the project, while the DNR staff member will devote 25% of her time to the project.

B. Project Impact and Long-term Strategy: This program will address the problem that children are spending increasingly less time outside and, consequently, know less about their environment and world. It responds to the needs identified in the 2009 Outdoor Education Legislative Report to increase outdoor learning opportunities for children and to train educators who are often uncomfortable taking youth outside for lessons. It also addresses outcomes outlined in the Minnesota Greenprint to provide increased environmental education opportunities for youth both at school and during play.

The goals of this project are 1) to create a series of outdoor, sequential, science-based lessons with targeted learning outcomes that address the new MN K-12 Science Standards, 2) to prepare adult leaders to deliver these lessons in after-school programs for 4th and 5th graders with the aim of improving their performance on the 5th grade Science MCA exams and 3) to establish a permanent program to offer these lessons throughout Minnesota.

Other state and national programs focus on outdoor exploration, play, and reflection with an emphasis on natural areas. This program emphasizes targeted science learning outcomes and use of the schoolyard as a means of investigating the environment. The curriculum will be developed and tested in schools with large minority enrollments. MN Master Naturalist staff will then train, place, and support volunteers offering the program in at least 50 after-school programs statewide.

C. Spending History:

Funding Source	M.L. 2005 or FY 2006-07	M.L. 2007 or FY 2008	M.L. 2008 or FY 2009	M.L. 2009 or FY 2010	M.L. 2010 or FY 2011
National Science Foundation	\$359,157.38	\$361,305.12	\$280,510.22	\$348,515.95	\$363,015.27

VIII. ACQUISITION/RESTORATION LIST: NA

IX. MAP(S): NA

X. RESEARCH ADDENDUM: NA

XI. REPORTING REQUIREMENTS:

Periodic work plan status update reports will be submitted not later than January 31, 2012; July 31, 2012; January 31, 2013; July 31, 2013; January 31, 2014; July 31, 2014; and January 31, 2015. A final report and associated products will be submitted between June 30 and August 1, 2015 as requested by the LCCMR.

Attachment A: Budget Detail for M.L. 2011 (FY 2012-13) Environment and Natural Resources Trust Fund Projects											
Project Title: Minnesota Junior Master Naturalist Program											
Legal Citation: ML 2011 First Special Session , Chapter 2,											
Project Manager: Robert B. Blair											
M.L. 2011 (FY 2012-13) ENRTF Appropriation: \$65,000											
Project Length and Completion Date: June 30, 2015											
Date of Update: January 1, 2015											
ENVIRONMENT AND NATURAL RESOURCES TRUST FUND BUDGET	Revised Activity 1 Budget 8/12/15	Amount Spent	Balance	Revised Activity 2 Budget 8/12/15	Amount Spent	Balance	Revised Activity 3 Budget 8/12/15	Amount Spent	Balance	TOTAL BUDGET	TOTAL BALANCE
BUDGET ITEM	Develop and Pilot-test Fall, Winter & Spring Curricula			Train Master Naturalist Volunteers & Field-test Curricula			Expand Program to 50 Sites Statewide.				
Personnel (Wages and Benefits)											
Director (Robert Blair) -- 11% FTE for three years, 33.3% Fringe Benefits	10,987	10,987	0	11,537	11,537	0	22,116	22,116	0	44,640	0
Coordinator -- 100% FTE for three years, 33.3% Fringe Benefits	54,986	54,986	0	57,736	57,736	0	100,936	86,058	14,878	213,658	14,878
Professional/Technical Contracts											0
Service contracts											0
Payment for teachers assisting with pilot- and field-testing -- \$500 per season per teacher	1,100	1,100	0							1,100	0
Equipment/Tools/Supplies											0
Teaching Supplies -- \$200 per season per site	2,212	2,212	0	0	0	0	4,813	4,813	0	7,025	0
Training Workshop Supplies -- \$50 per volunteer	400	400	0	600	600	0	2,500	2,500	0	3,500	0
Office supplies	250	250	0	250	250	0	250	250	0	750	0
Capital equipment over \$3,500	0		0	0		0	0		0	0	0
Fee Title Acquisition	0		0	0		0	0		0	0	0
Easement Acquisition	0		0	0		0	0		0	0	0
Professional Services for Acquisition	0		0	0		0	0		0	0	0
Printing	0		0	0		0	0		0	0	0
Travel expenses in Minnesota			0						0	0	0
Mileage for staff to conduct training and evaluation calculated at \$0.50 per mile	588	574	14	1,000	141	859	2,260	935	1,325	3,848	2,198
Other (Subaward to DNR)									0	0	0
Manager -- 25% FTE for three years, 37.2% Fringe Benefits	23,657	23,657	0	24,840	24,840	0	26,082	19,747	6,335	74,579	6,335
Graphic Design	1,000	1,000	0	5,000	5,000	0	5,000	5,000	0	11,000	0
Unallocated							4,900		4,900	4,900	4,900
COLUMN TOTAL	\$95,180	\$95,166	\$14	\$100,963	\$100,104	\$859	\$168,857	\$141,419	\$27,438	\$365,000	\$28,311

The Minnesota Master Naturalist Explorers Program

Is in your neighborhood



Happens in all seasons



Is for everyone



Is fun!



Minnesota Master Naturalist Explorers is an after-school program for youths 8 – 12 years old. If you are interested in developing an after-school program using the program materials, visit www.minnesotamasternaturalist.org/explorers

UNIVERSITY OF MINNESOTA
EXTENSION



Date: _____



Dear _____



I had a _____ time at Explorers today! We learned about _____. When we went outside we saw _____. I also noticed _____. My favorite part about today was when _____.

Sincerely,



Date: _____

Dear families,

Today was a wonderful day with Explorers! Our lesson was about _____ Ask your student about _____, our hands-on object of the day. If you have time this week, you might consider exploring _____ as a family. Next week we will be talking about _____. Please remind your student to bring _____.

Sincerely,

Minnesota Master Naturalist

Master Naturalist Explorers Planning Template

Date _____

Greeting or Icebreaker	
Background information What will participants need to know for the day?	
Objectives What do you want participants to get out of the day?	
Activity/activities What are you going to do? Where can you find the lesson plan?	
Materials needed	
Safety considerations What could affect participants' safety? Ex. weather, insects, poison ivy, sharp materials, etc	
Reflection tool How are you going to review the day? Ex. Journaling, group discussion, individual reflect/rethink, etc	

How to Find an After School Partner

-Identify a site (often a school or community center) and contact person. If you do not know who to contact, browse the site's website. Each site will be different, but some key words to search for are extended day care, targeted services, community education, and enrichment.

-Once you have identified a teacher or coordinator at the site, introduce yourself and the program you would like to lead. You may want to do this in person or through email. Provide the site with specific examples of activities you may do with youth.

-Speak with the teacher or coordinator to determine the dates and times of your program. Depending on the site, schools may have participants gathered already or they may need time to advertise and register participants. Within the days the site has available, you may choose the dates and number of sessions that you will be available. Typically, an after school session will last between 45 and 90 minutes.

-Ask the site about their policy on background checks and follow up if you are requested to submit one.

-Visit the site to preview the indoor and outdoor teaching spaces.

-Prepare for lessons by gathering materials and familiarizing yourself with the activities.

-Before the first session, send a letter to the site coordinator to distribute to families. This letter should include information like the exact days and times you will be meeting as well as a reminder to dress for all weather conditions.



Insects

R V P M N Z N X A D D C T H Q A Q R F M Y Y G X G
 Q K Z P W E S O A C B H E L X K E I C V G H R W D
 D E M G A X H E P N X A G V S U L U H C R Z K X Y
 I C S D G B A X X O D N T T W Z M P Q Y T J U K C
 P J P X F Z J Z T D Q C D G X V O J L T H R I Y I
 W A L Q Z X F I F L G I D G C F H O J H V X P W Q
 F N U W U K M E Z P T V T P J L P A M M Y B K O J
 F X H L B J L S I J Z U O Q Q V N X V I B U N Y L
 U M U R Y T Y Y Z D F X Y U U W M G N R H M G K L
 G O A I K H Q J W M S H Q U O F X D D S B U R O F
 C Y C L E A N B N E M O D B A Y W G R C Q Q X N H
 G R V U N R R L V V T J C A N N G F Z E S W K C U
 J W D K L B F P A M O Z D D S O N Y T A J L M I Z
 Y Z D B I F R H A R E W H T M L Q D X G A B Z P H
 S E Z N X X U E H K V E Y A F O Q R C Z Y U V L W
 Y C G Z N C J R N J F A D B P C U U J N J D L L U
 T A L N M P X O Y B P Z U A W U C A C T F C H V S
 T B Q G O Q E M D P K T U D T X P T B N C D U Y Y
 V Z W C X I E O E U T F X U L U D R J P H E X Z D
 U G O S P L K N G E T Y G L Y N M H X Z A I S D U
 X Y M E M D L E P G C W B T T G O A U M K E Z N A
 O N V D O U H F G G A D L J F K P J Q E F I L O I
 D Y S D Y C L E D P T G V C Y O D D Q B N W W G Q
 U Q R M D Y F J P Q O D Z M H Z Z J Z X L P W Y M
 H M F M Y T A M Z Q N S I T T Y I A H V M F B S N

ABDOMEN
 BUTTERFLY
 EGG
 LARVA
 PUPA

ADULT
 COLONY
 HEAD
 LIFE
 THORAX

ANT
 CYCLE
 INSECT
 PHEROMONE



Name: _____

Dandelions

Write the word on the line.

1. nerhat _____
2. amiftnle _____
3. anmtes _____
4. aptle _____
5. elasp _____
6. brcta _____
7. ayovr _____
8. flerot _____
9. tllopnaei _____
10. atcrne _____
11. cellc ieyf _____
12. upsppa _____



Dandelions Answer sheet

- | | |
|----------------|------------|
| 1. nerhat | anther |
| 2. amiftnle | filament |
| 3. anmtes | stamen |
| 4. aptle | petal |
| 5. elasp | sepal |
| 6. brcta | bract |
| 7. ayovr | ovary |
| 8. flerot | floret |
| 9. tillopnaei | pollinate |
| 10. atcrne | nectar |
| 11. cellc ieyf | life cycle |
| 12. upspapa | pappus |



Name: _____

Leaf Litter word scramble

Please unscramble the words below

1. afle rletti

2. odscpeorem

3. sraenvecg

4. minorevo

5. iacvrone

6. ovrerehbi

7. ucpdorer

8. soil

9. nocaigr mttera

10. usmhu

11. ersnucom



Name _____

Spelling Words - Missing Letters

Write the missing letter or letters in each word.

xylem

deciduous

roots

photosynthesis

cambium

coniferous

nutrients

phloem

circumference

leaves

bark

diameter

chlorophyll

1. camb_um

2.

pho_osyn_hesis

3. _iamet_r

4. _oots

5. b__k

6. le_ve_

7. ph_oem

8. c_lorophy_l

9. decid_ous

10. nut_ie_ts

11. con_i_erous

12.

_ircumferen_e

13. _yl_m



Spelling Words - Missing Letters - Answers

Write the missing letter or letters in each word.

xylem

deciduous

roots

photosynthesis

cambium

coniferous

nutrients

phloem

circumference

leaves

bark

diameter

chlorophyll

1. cambium

8. chlorophyll

2.

9. deciduous

photosynthesis

10. nutrients

3. diameter

11. coniferous

4. roots

12.

5. bark

circumference

6. leaves

13. xylem

7. phloem



Name _____

Fit each of the words below into a word shape puzzle.

- soil mineral organicmatter sand silt clay
- rock pebble gravel erosion parentmaterial

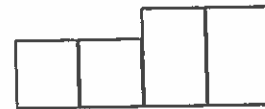
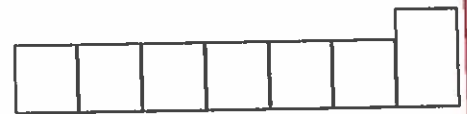
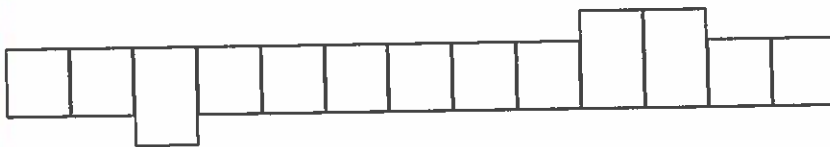
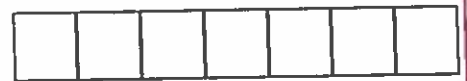
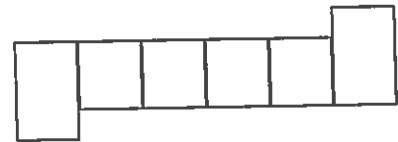
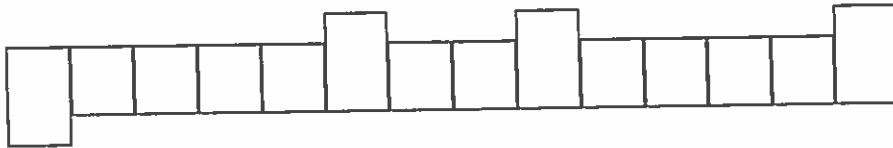
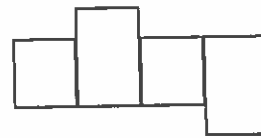
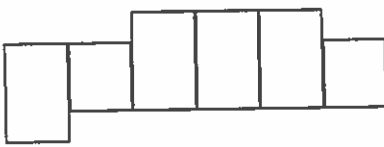



Answers

Fit each of the words below into a word shape puzzle.

soil mineral organicmatter sand silt clay
rock pebble gravel erosion parentmaterial

pebble

clay

parentmaterial

gravel

rock

erosion

organicmatter

mineral

soil

silt

sand



Weather

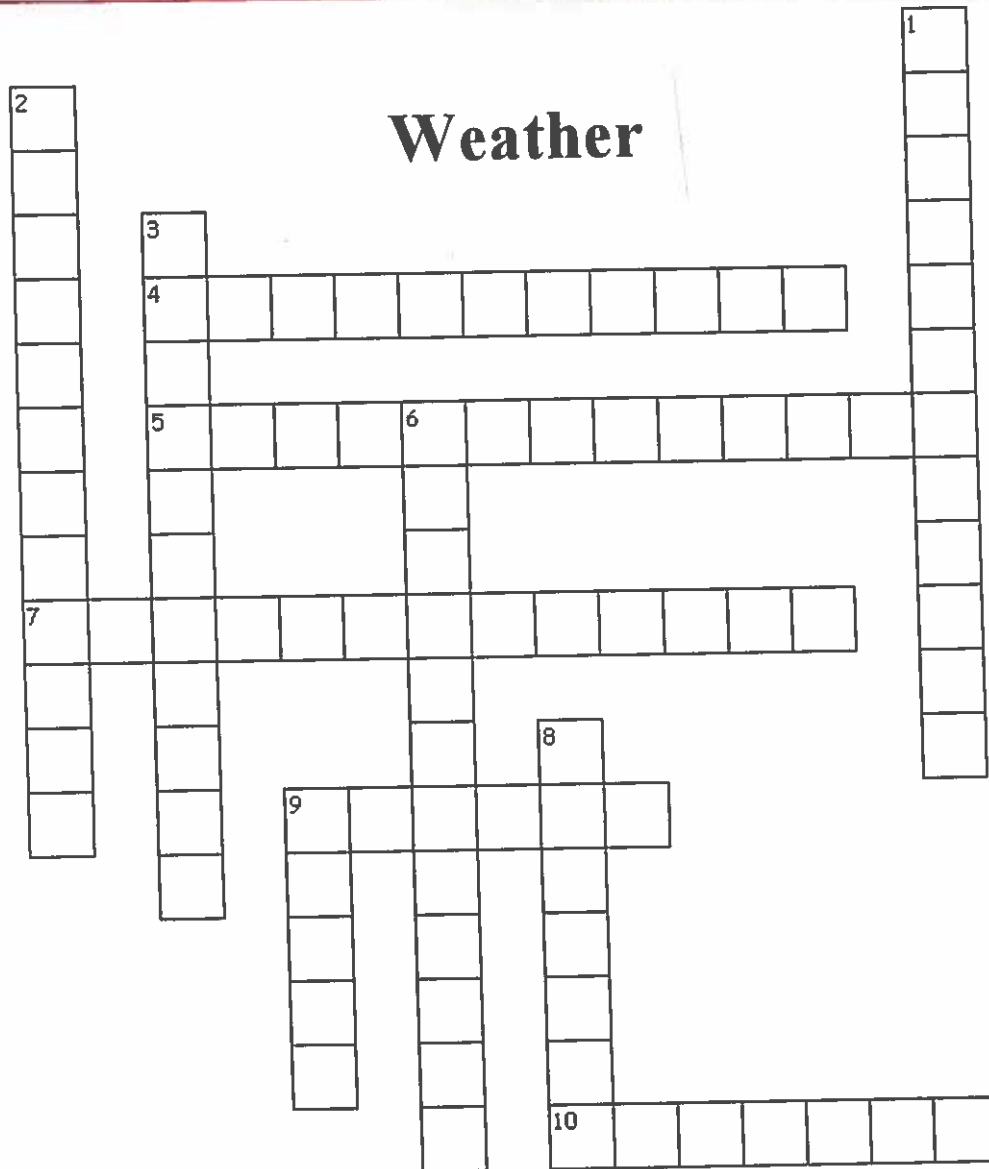

Across

- 4. The process of water molecules condensing and rising into the atmosphere
- 5. Moisture, often in the form of rain or snow, that falls to the ground
- 7. When plants give off water vapor through tiny pores in their leaves
- 9. High, wispy thing cloud
- 10. Low, flat clouds that spread out across the sky

Down

- 1. Clouds that can grow very large and tall
- 2. The opposite of evaporation, when water vapor in the air converts into liquid form
- 3. Measurement of warmth
- 6. The process of water soaking into the soil from the ground level
- 8. Big puffy clouds
- 9. Made up of many water droplets



COOL FALL FACT

Monarchs travel up to 100 miles a day taking up to two months to complete their migration to winter habitats.



MINNESOTA MASTER NATURALIST

UNIVERSITY OF MINNESOTA
EXTENSION



MASTER NATURALIST EXPLORERS

Fall Nature Journal

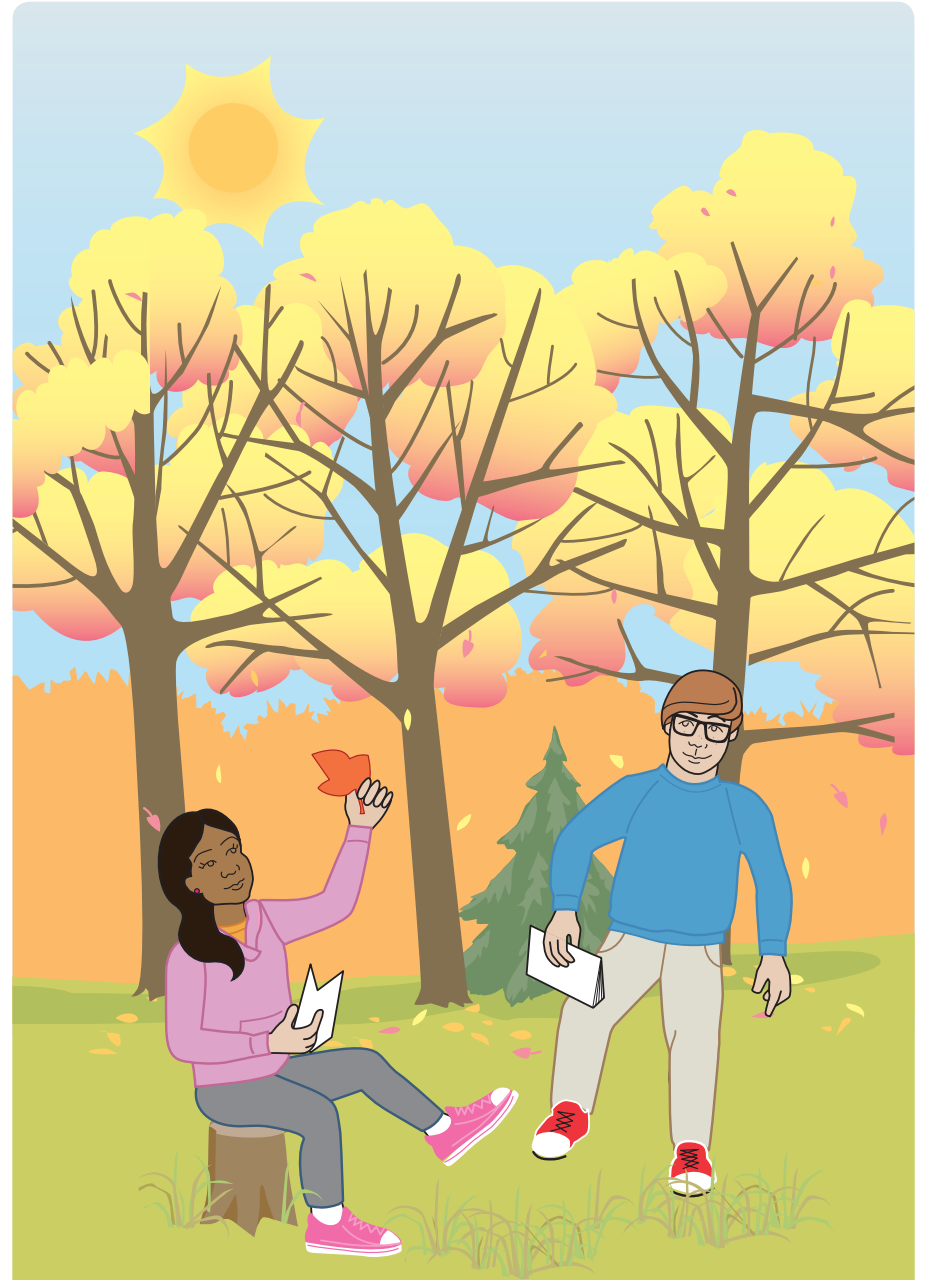

Name _____

Date _____

The Minnesota Master Naturalist Explorers Program connects adult volunteers with youth in an after-school setting. The goal of the Explorers Program is to offer fun, outdoor, science-based educational opportunities for elementary students to learn about the ecology and natural history of their schoolyard, neighborhood, nearby natural areas, and the entire state.

Explorers is a component of the Minnesota Master Naturalist Program whose mission is to promote awareness, understanding, and stewardship of Minnesota's natural environment by developing a corps of well-informed citizens dedicated to conservation education and service within their communities.

Acknowledgments

Authors: Dawn A. Flinn, Minnesota Department of Natural Resources; Darren Lochner and Robert B. Blair, University of Minnesota Extension

Reviewers: Bev Blomgren, Pete Cleary, Sara Aker

Designer: Amy Beyer, Minnesota Department of Natural Resources

A Quick Guide to Leaf Types (page 19) is adapted from the poster *Minnesota's Forest Treasures*, MN DNR, Forestry.

Funding for this project was provided by a grant from the Minnesota Environment and Natural Resources Trust Fund.



© 2015, Regents of the University of Minnesota. All rights reserved. Send copyright permission inquiries to: Copyright Coordinator, University of Minnesota Extension, 405 Coffey Hall, 1420 Eckles Avenue, St. Paul, MN 55108-6068. Email to extcopy@umn.edu or fax to (612) 625-3967.

University of Minnesota Extension and Minnesota Department of Natural Resources provides equal access to and opportunity in its programs, facilities, and employment without regard to race, color, creed, religion, national origin, gender, age, marital status, disability, public assistance status, veteran status, sexual orientation, gender identity, or gender expression. This material is available in alternative formats upon request.

Answers

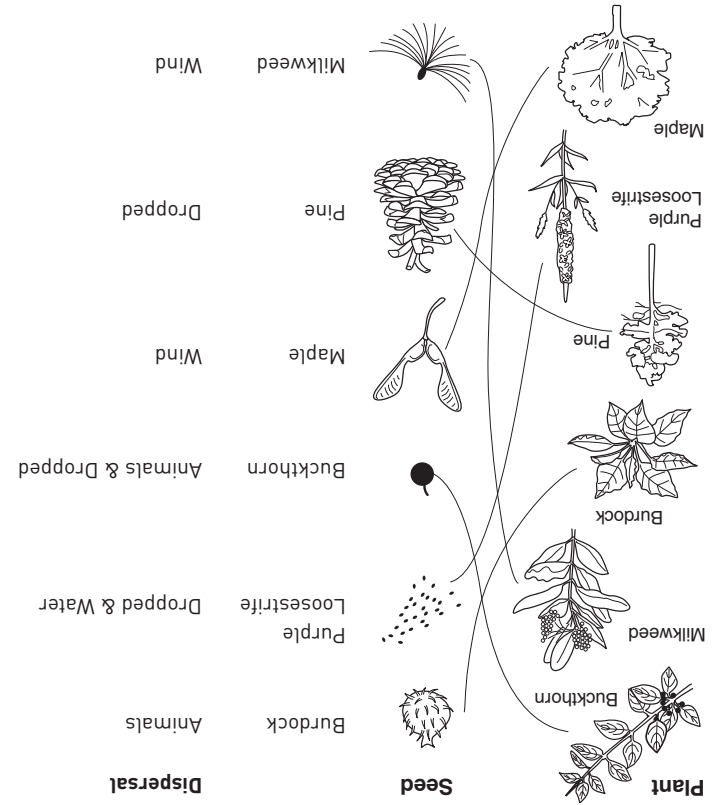

Seed Dispersal page 14

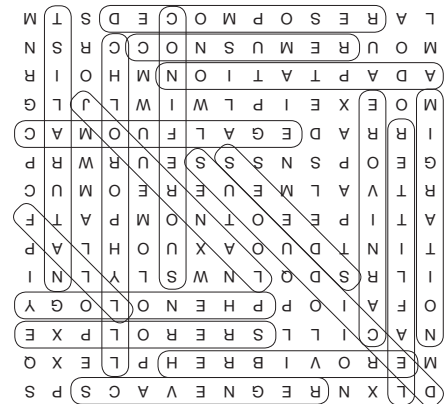

Nature Word Search page 13

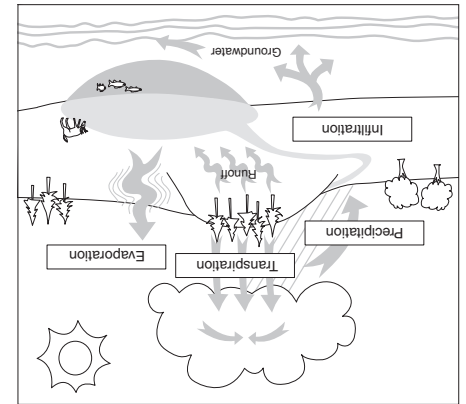

Water Cycle page 8

Vocabulary Words

phenology – the science of seasonal changes and their effect on the natural world

journal – notebook or binder used to make recordings, drawings, and write thoughts and reflections

producer – organism that produces its own food mainly through the process of photosynthesis

consumer – organism that consumes other organisms to get its nutrients

decomposer – organism whose role is to break down the remains of other living things

scavenger – organism that eats dead matter

herbivore – animal that eats plants

carnivore – animal that eats meat

omnivore – animal that eats both plants and meat

leaf litter – organic matter found on forest floor

soil – substance containing both small rock particles and decaying matter

seed – reproductive part of a flowering plants life cycle

seed dispersal – mechanism for spreading seeds to another location

COOL FALL FACT

People from all over the world have visited Hawk Ridge in Duluth, Minnesota to watch the fall migration of thousands of raptors.



Introduction

Who is a Master Naturalist Explorer?

It is someone like YOU! A kid who is interested in nature, wants to learn more about it, and have fun exploring the outdoors.

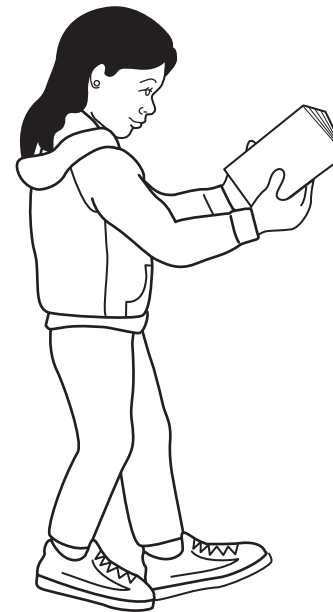

Please do the following:

Be safe.

Be respectful of each other and nature.

Have fun!

What is a nature journal?

A nature journal is a booklet that helps you capture your experiences in nature. It is a place to write, sketch and record your personal observations and thoughts about nature. It is a great way to keep track of your discoveries over time.



Minnesota Biomes

In general, a biome is a large area of land with the same type of plant communities.

Put a star on the map to mark the location of your Explorers program.

What biome are you in? _____

COOL FALL FACT

Minnesota's waters flow outward in three directions to the Gulf of Mexico, Atlantic Ocean and Hudson Bay.

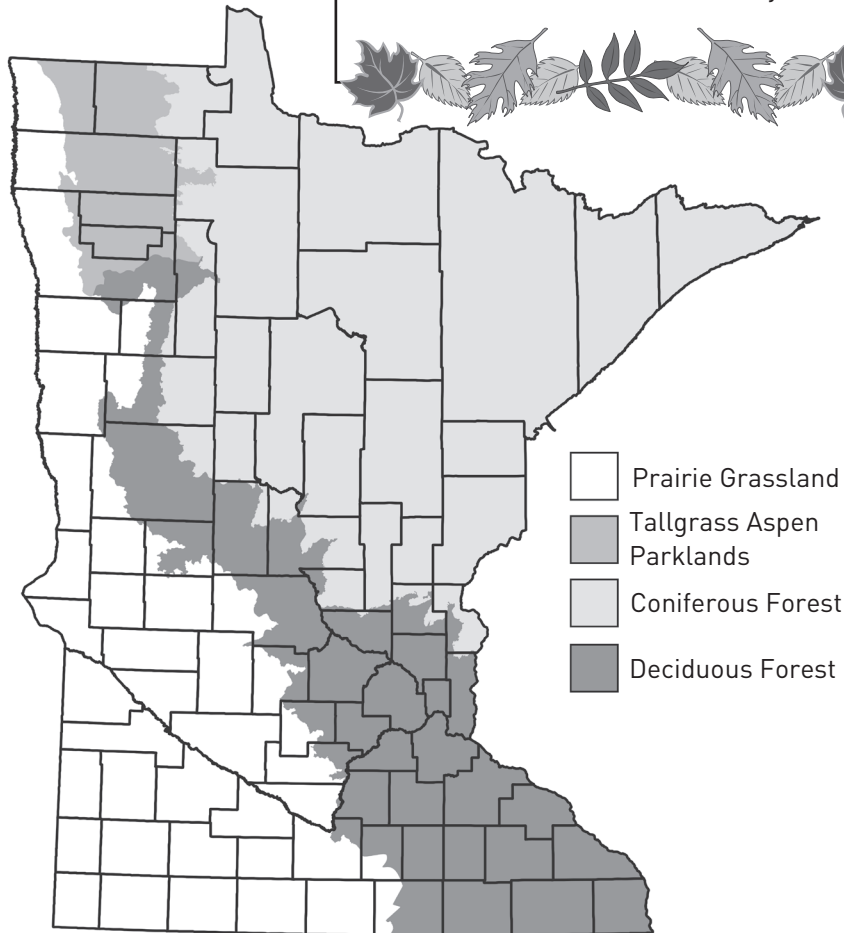

I Promise I Will Help Nature by:

Signature _____



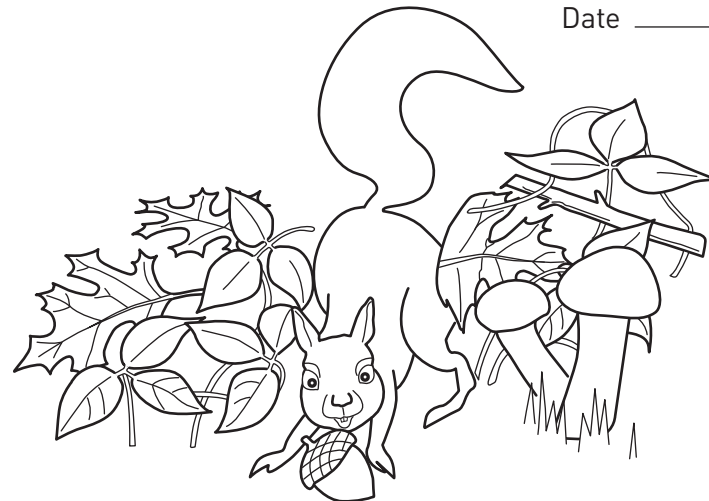

Date _____



Nature Observations/Field Sketches

Nature Observation

Explore your site. Write or draw your nature observations in the boxes below.

	I see		I feel	
	I smell		I hear	

COOL FALL FACT

Thousands of acorns are produced by the time an oak tree is 80 years old.



Draw a Map of Your Site

Create a birds-eye view map of your Explorers program site. Draw in large items such as buildings, playgrounds, streets, grassy areas, trails, forests or gardens. Create a key to identify major features.

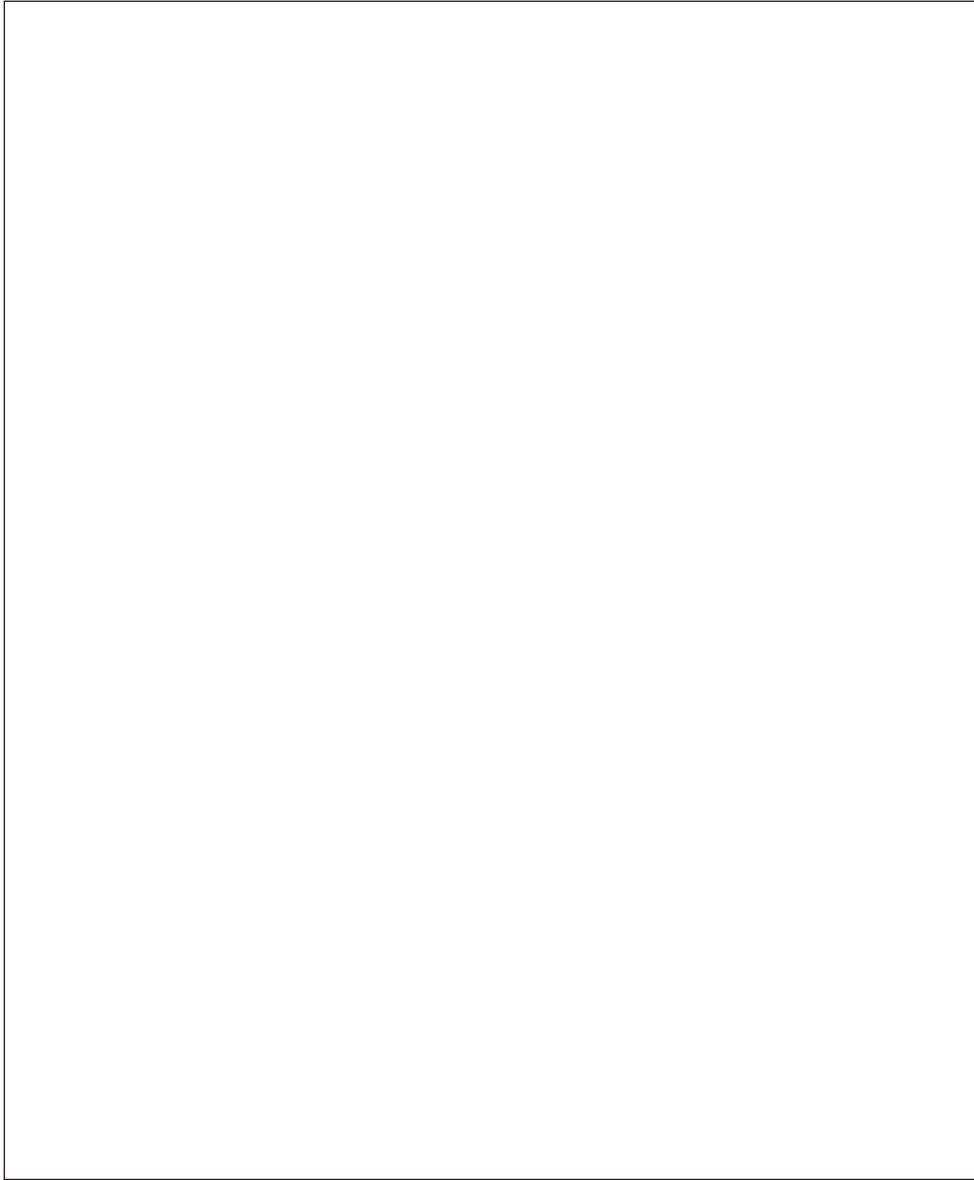

Nature Observations/Field Sketches

How to Draw

Take one step at a time to draw an item such as a leaf.

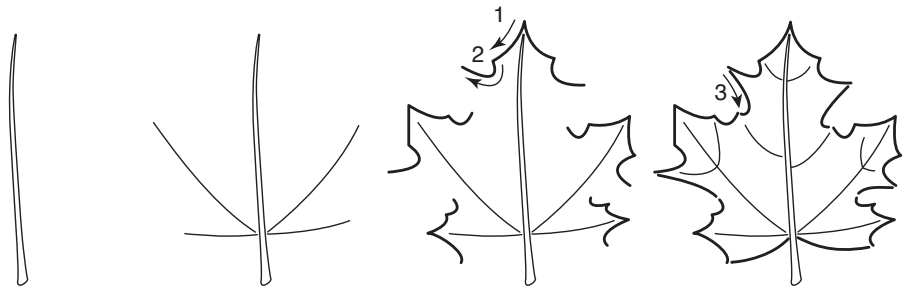
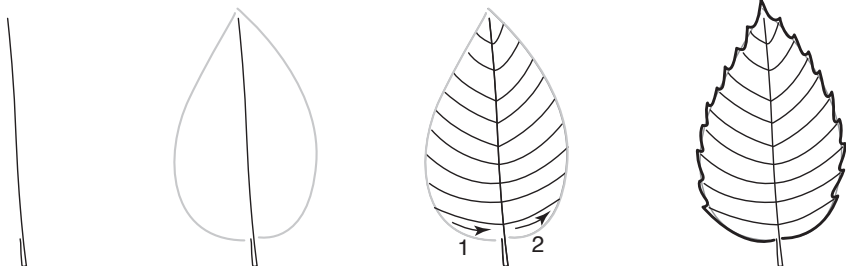

Key

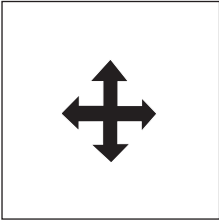

Phenology

Phenology is the science of seasonal changes and their effect on the natural world. In the squares draw and/or write natural things that may be happening in the different seasons.

Spring	Summer
Fall	Winter

COOL FALL FACT

Yellow and orange leaf colors are hidden under the green chlorophyll until autumn.







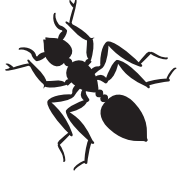

Leaf Observation

Collect and attach one or more leaves below, or do a leaf rubbing.

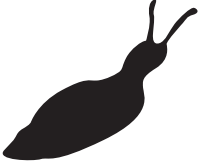
Leaf Litter Critters

Gently explore the leaf litter and check off critters you find. Draw others that aren't on the list.

Ant <input type="checkbox"/> 	Beetle <input type="checkbox"/> 	Spider <input type="checkbox"/> 
Slug <input type="checkbox"/> 	Woodlouse <input type="checkbox"/> 	Centipede <input type="checkbox"/> 
Cricket <input type="checkbox"/> 	Caterpillar <input type="checkbox"/> 	Other <input type="checkbox"/>
Other <input type="checkbox"/>	Other <input type="checkbox"/>	Other <input type="checkbox"/>

Fall Phenology

The first time you discover each item below check it off and write down the date. Add your own things to watch for.



Date: _____

- Leaves change color _____
- Squirrels burying food _____
- Asian lady beetles or box elder bugs gathering _____
- Someone raking leaves _____
- Juncos return _____
- Ducks or geese flying overhead _____
- First snowflakes _____
- Robins gathering in groups _____
- Daylight savings time ends _____
- Acorns falling to ground _____
- Hear someone scraping frost off their car windshield _____
- Ice begins to form on local lake/wetland _____
- Wear winter or warmer jacket _____
- Leaves begin falling from trees _____
- Caterpillars crawling on ground _____
- First frost _____
- Trees mostly leafless _____
- First morning you can see your breath _____
- Other _____ _____
- Other _____ _____

Water Cycle

Fill in the blanks with the word that best describes what is happening in the water cycle.

Transpiration Evaporation Precipitation Infiltration

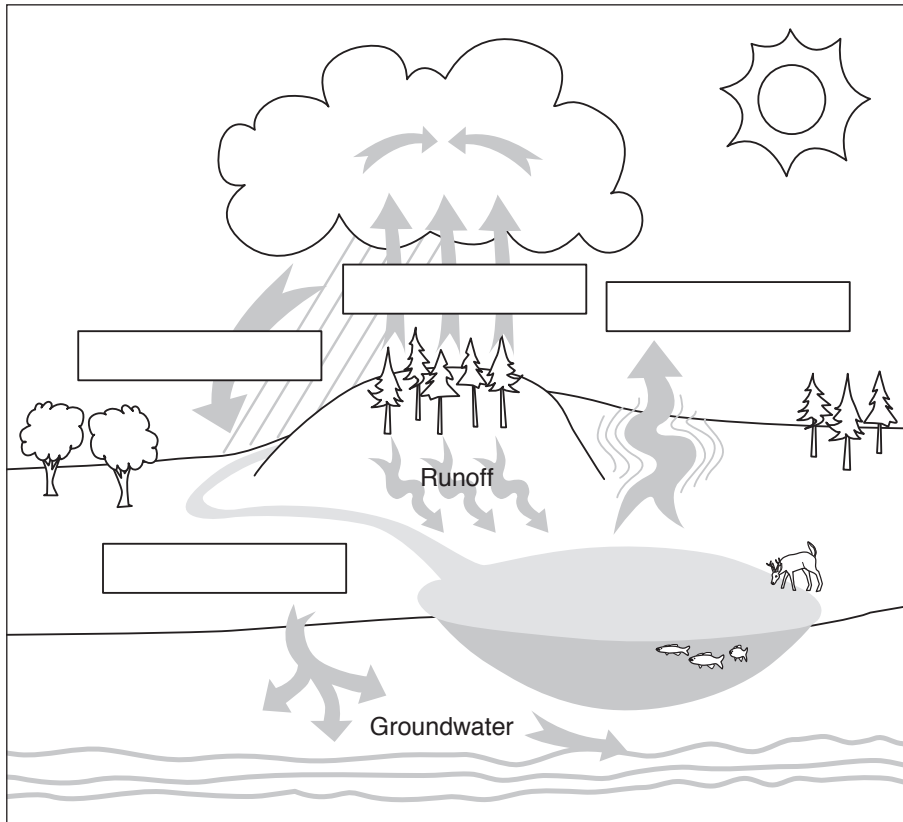

COOL FALL FACT

The idea for VELCRO® came from a burdock seed.



Scavenger Hunt



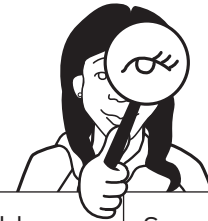









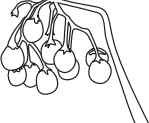

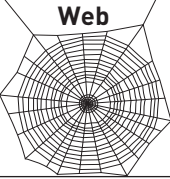
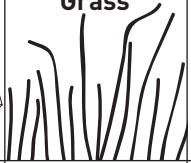





Check-off each item you find and then sketch or write what it is.

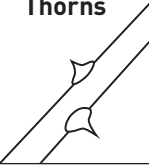

<p>Something that needs air/oxygen to survive <input type="checkbox"/></p>	<p>Something older than yourself <input type="checkbox"/></p>	<p>Something smaller than your thumb <input type="checkbox"/></p>
<p>Something that flies <input type="checkbox"/></p>	<p>Something taller than you <input type="checkbox"/></p>	<p>Something younger than yourself <input type="checkbox"/></p>
<p>Something that you have not seen before <input type="checkbox"/></p>	<p>Something with a scent <input type="checkbox"/></p>	<p>Something with a bud <input type="checkbox"/></p>

Fall Nature Bingo

Take a walk outside and try to find each one of the objects on the bingo board. Cross off the ones that you find. Yell "nature!" if you find five objects in a row or diagonally.

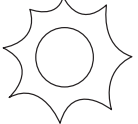
Ant 	Clouds 	Berries 	Soil 	Other
Seeds 	Web 	Grass 	Insect 	Wind 
Flying bird 	Mushroom 	Free Space	Squirrel 	Decaying leaf 
Rocks 	Animal sound 	Coniferous tree 	Thorns 	Fly 
Squirrel nest 	Butterfly 	Flower 	Bark 	Sun 

COOL FALL FACT

You are most likely to see Northern Lights (*aurora borealis*) in the fall.



Common Cloud Types

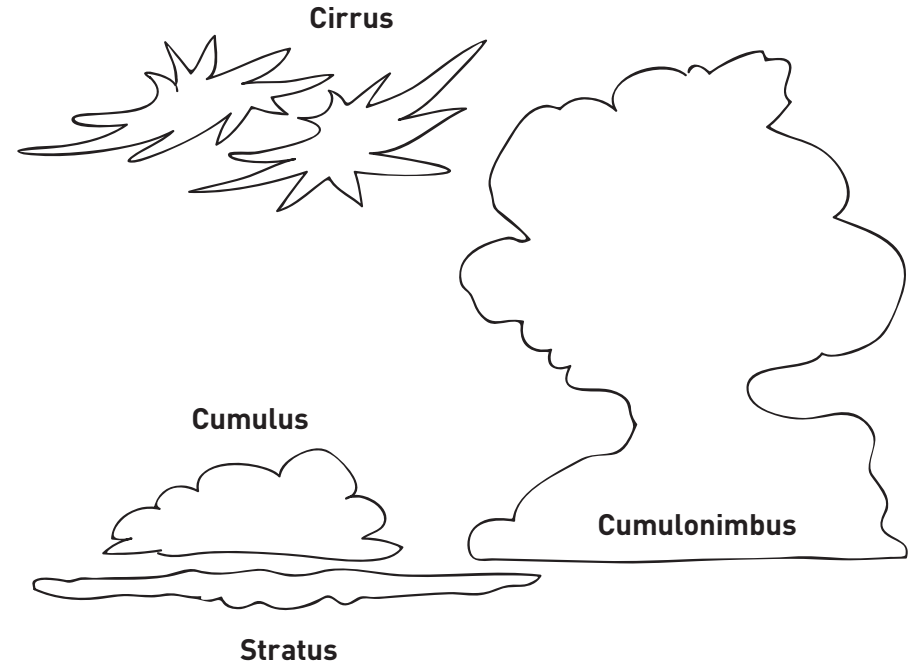

COOL FALL FACT

Migrating hawks and other soaring birds travel during the day using thermal updrafts while most songbirds travel at night.



Weather Tracker

Create a bar graph for temperature and wind speed. Enter a symbol for cloud conditions and precipitation.

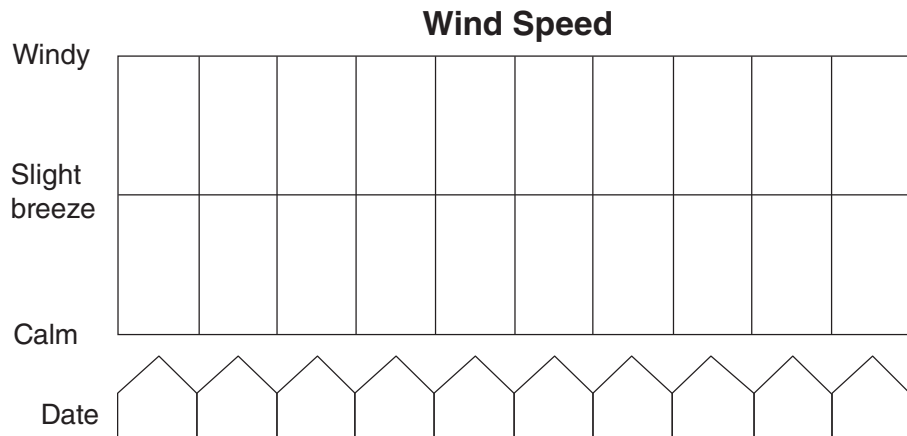
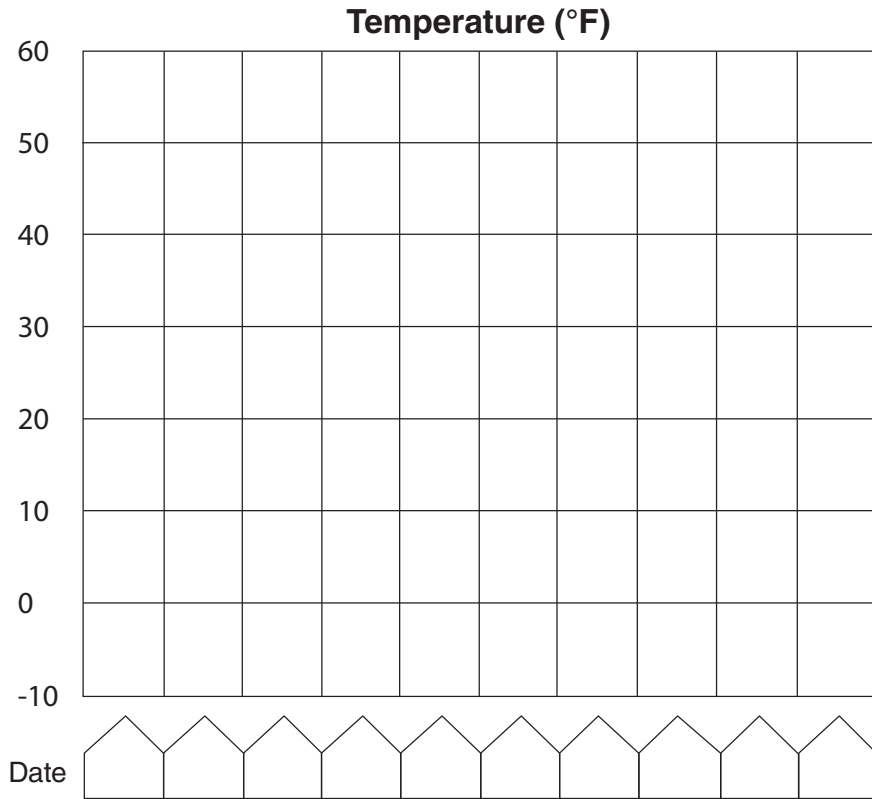

A Quick Guide to Leaf Types

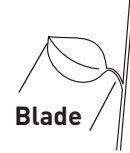

Blade

Simple leaves have only one leaf blade.



Leaflets

Compound leaves have many leaflets.



Opposite leaves grow directly across from one another, in pairs.

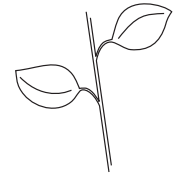

Alternate leaves grow singly along a branch, with space between each leaf.

Leaf edges

Smooth leaves have smooth edges. Toothed leaves have jagged edges. Lobed leaves have rounded sections.

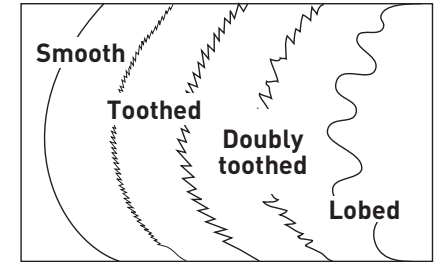

Coniferous

Red pine or Norway pine (Minnesota's state tree)

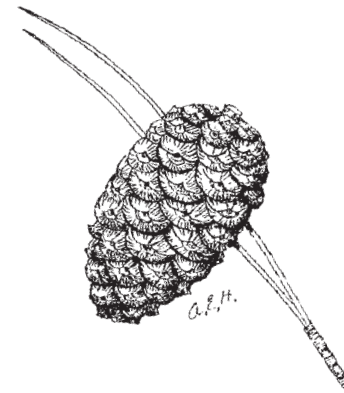

Deciduous

Red oak

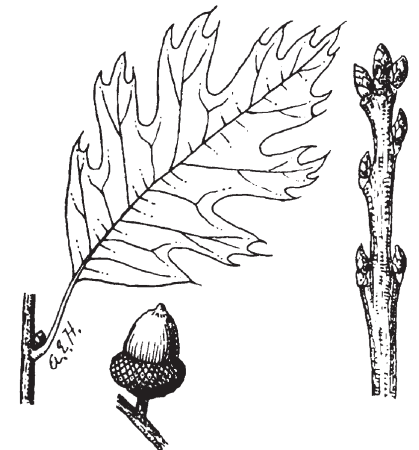

Leaves and Branches

Draw the items below.

**Opposite
branching**

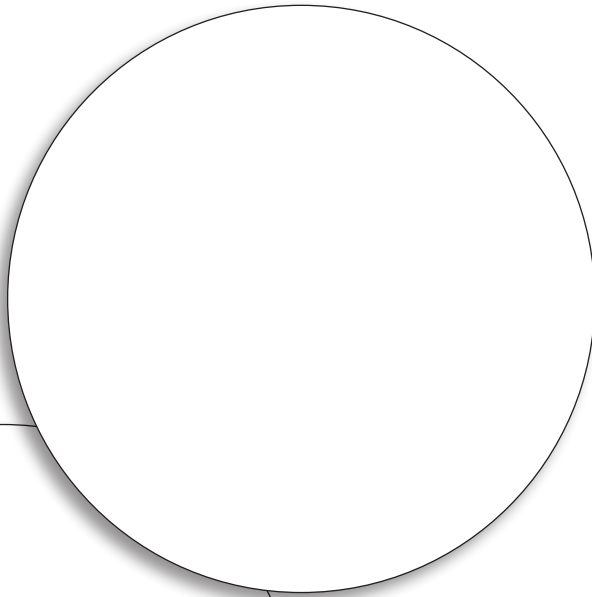

**Alternate
branching**

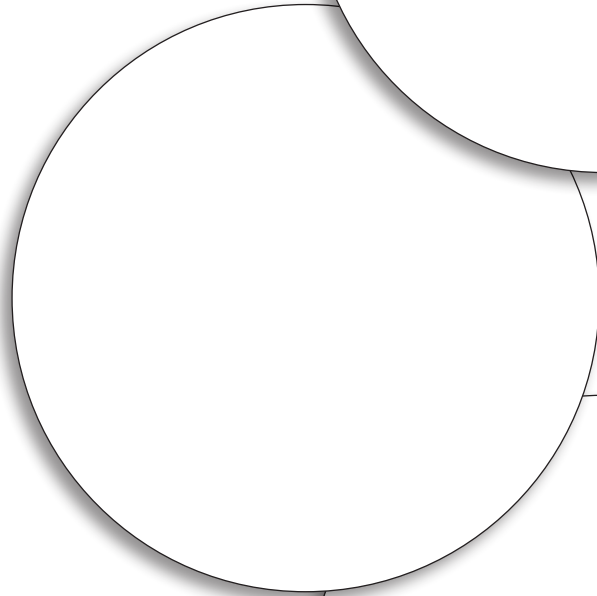

Leaves

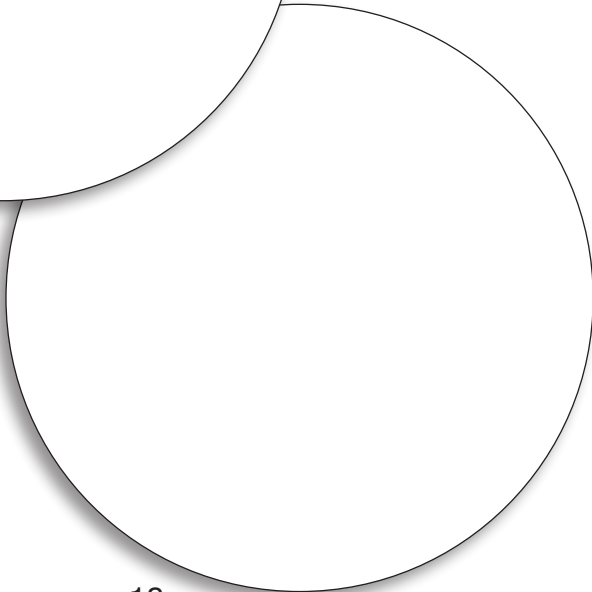

Cloud Conditions



Cirrus



Cumulus



Stratus



Cumulonimbus



None

--	--	--	--	--

Date



--	--	--	--	--

Date



Precipitation



Rain



Sleet



Snow



None

--	--	--	--	--

Date



--	--	--	--	--

Date



Temperature

32 degrees Fahrenheit is freezing

0 degrees Celsius is freezing

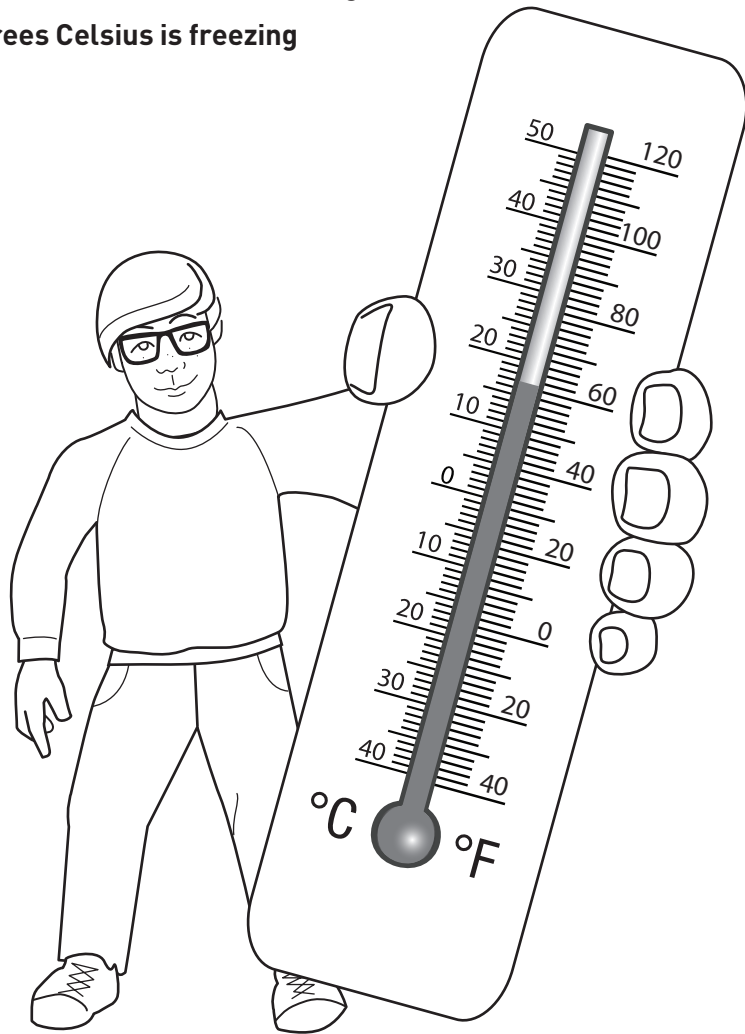

Conversion formulas

Fahrenheit to Celsius

$$^{\circ}\text{C} = (^{\circ}\text{F} - 32) \times \frac{5}{9}$$

or

$$^{\circ}\text{C} = (^{\circ}\text{F} - 32) \times .56$$

Celsius to Fahrenheit

$$^{\circ}\text{F} = ^{\circ}\text{C} \times \frac{9}{5} + 32$$

or

$$^{\circ}\text{F} = ^{\circ}\text{C} \times 1.8 + 32$$

Inside a Tree

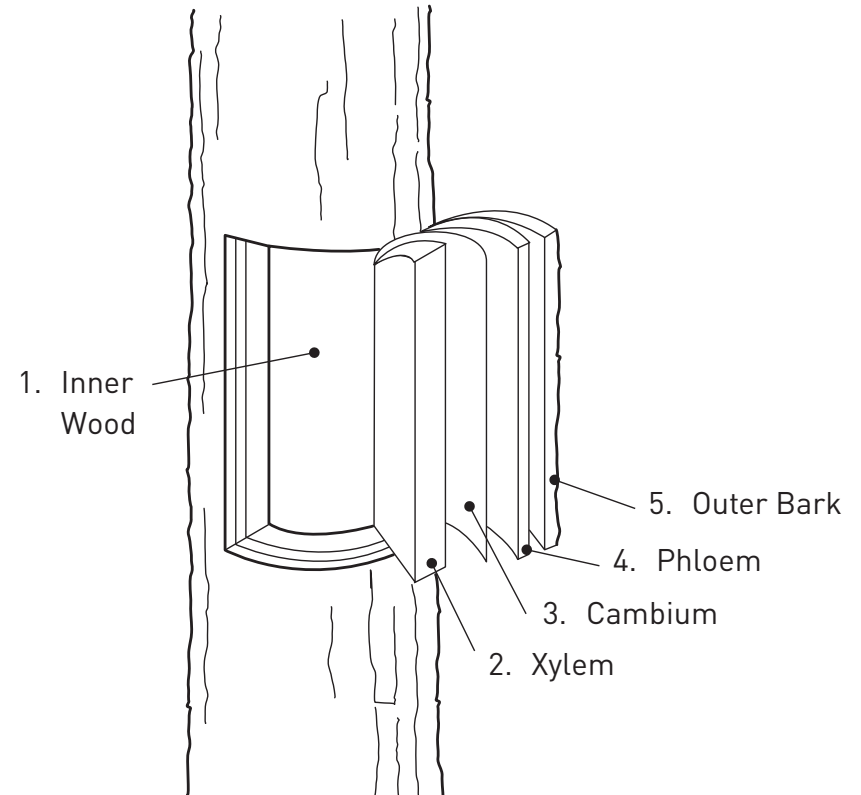



1. Inner Wood—supports tree, stores growing compounds and sugars
2. Xylem (zahy-luh m)—carries water and minerals from roots to leaves
3. Cambium (kam-bee-uh m)—makes trunk, branches and roots thicker
4. Phloem (floh-em)—carries food (sap) from leaves to rest of tree
5. Outer Bark—dead tissue that protects the tree from injury

Field Guide

Field guides help you to identify plants and animals found in nature. There are many kinds, big and small, but all contain some basic information such as: common name, scientific name, a picture and description.

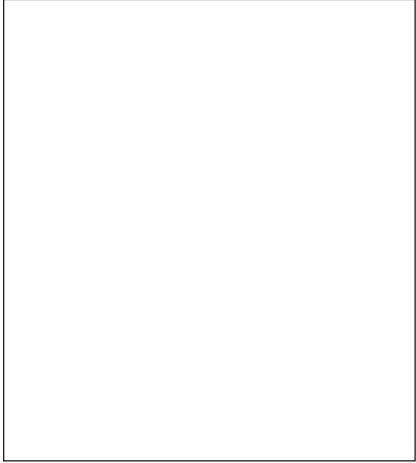
Create your own imaginary plant or animal field guide entry below.

Common Name	

Scientific Name	

Description	

Nature Word Search

Find and circle the words below. Words can be found up, down, across, diagonally, forward and backward.







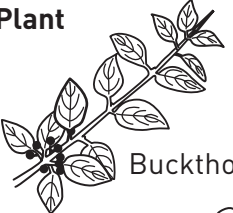

```

D L X N R E G N E V A C S P S
M E R O V I B R E H P L E X Q
N A C I L L S R E R O L P X E
O F A I O P P H E N O L O G Y
I L R S D Q L N W S L Y L N I
T I N T D U O A X U O H L A P
A T I P E E O T N O M P A T F
R T V A L M E U E R E O M U C
G E O P S N S S S E U R W R P
I R R A D E G A L F U O M A C
M O E X E I P L W I W L J L G
A D A P T A T I O N M H O I R
M O U R E M U S N O C C R S N
L A R E S O P M O C E D S T M
    
```

- | | | |
|-------------|------------|------------|
| ADAPTATION | DECIDUOUS | LEAFLITTER |
| CAMOUFLAGE | DECOMPOSER | MIGRATION |
| CARNIVORE | EXPLORERS | NATURALIST |
| CHLOROPHYLL | FALL | PHENOLOGY |
| CONIFEROUS | HERBIVORE | SCAVENGER |
| CONSUMER | JOURNAL | SEEDS |

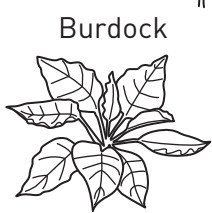
Seed Dispersal

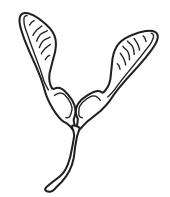
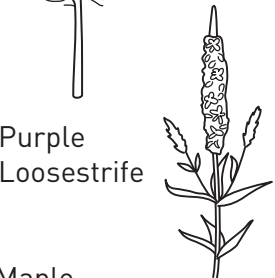
Match the plant to the seed and the seed to its dispersal method.
 Note: some seeds may have more than one way of dispersing.

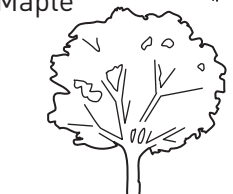
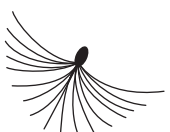
Plant	Seed	Dispersal
 Buckthorn		<input type="text" value="Wind"/>
 Milkweed		
 Burdock		<input type="text" value="Animals"/>
 Pine		<input type="text" value="Dropped"/>
 Purple Loosestrife		
 Maple		<input type="text" value="Water"/>

Seed Collection

Look for the seed types below and attach some examples.

Sticks to clothes	Travels over one meter when blown on
Seed head containing 20+ seeds	Hard seed with thick coat
Fruit with seed inside	Super tiny seed



UNIVERSITY OF MINNESOTA | EXTENSION



MINNESOTA MASTER NATURALIST

Minnesota Master Naturalist Explorers Fall Curriculum

CHANGE IS COMING AS NATURE PREPARES FOR WINTER



IN PARTNERSHIP WITH:



Minnesota Master Naturalist Explorers Fall Curriculum

CHANGE IS COMING AS NATURE PREPARES FOR WINTER

Authors:

Dawn Flinn, Education Coordinator, Minnesota Department of Natural Resources
Britt Forsberg, Explorers Coordinator, University of Minnesota Extension
Darren Lochner, Explorers Coordinator, University of Minnesota Extension

Curriculum Reviewers:

Sara Aker, Prior Lake Savage School District
Bev Blomgren, Minnesota Master Naturalist Volunteer
Pete Cleary, Naturalist, Dodge Nature Center

Partners/Sponsors:

Funding for this project was provided by the Minnesota Environment and Natural Resources Trust Fund as recommended by the Legislative-Citizen Commission on Minnesota Resources (LCCMR).

Portions of this material are reprinted with permission from Strauss, A.L., Homayoun, T., Meyer, R., Nippolt, P.L., Oberhauser, K., Peterson, C., Rager, A. & Young-Isebrand, E. (2015). Driven to Discover: Facilitator's Guide to Citizen Science. St. Paul, MN: University of Minnesota Extension. For more information about the Driven to Discover project, please visit www.extension.umn.edu/citizenscience.

Table of Contents

GETTING STARTED WITH EXPLORERS	4
ICEBREAKERS	5
Nature Makes Me Feel	5
Who am I?	5
Animal Search	5
ACTIVITIES	
NATURE JOURNALING	6
Constructing a Nature Journal	8
Onion Hike	8
Bicycle Spokes	8
NATURE OBSERVATION BASICS	9
Closer Look	10
Paint Chips	11
Slice of Silence	11
FALL WEATHER WATCH	12
Beaufort Scale	14
Find the Wind	14
Transpiring Leaves	14
GETTING TO KNOW LEAVES	15
Collecting Leaves	16
As Special Place Through the Seasons	16
SEEDS ON THE MOVE	17
Milkweed Seed Race	18
Just the Facts, Ma'am	19
Seed Engineer	19
LEAF LITTER SEARCH	20
From Leaf Litter to Topsoil	21
INTRODUCTION TO A TREE	22
Know Your Branch	23
Connect the Branches	24
Meet a Tree	24
Tree Height	24
CAMOUFLAGE AND ADAPTATION	26
Find a Pencil	27
Habitat I Spy	27

NATURE BINGO	28
Question Trail	28
EXPLORERS SCAVENGER HUNT	29
Nature Alphabet Search	29
Scavenger Hunt with a Twist	29
Nature Wristband	30

GETTING STARTED WITH EXPLORERS

The Minnesota Master Naturalist Explorers program, developed in 2011, worked with elementary students across the state of Minnesota to foster their curiosity about the world and provided an opportunity for Master Naturalist volunteers to share their knowledge and passion for the outdoors with youth. The Minnesota Master Naturalist program, a partnership between the University of Minnesota Extension and the Minnesota Department of Natural Resources, operated the Explorers program with generous support from the Legislative-Citizen Commission on Minnesota Resources (LCCMR) through the end of the grant period on June 30, 2015. The following materials were developed to assist Master Naturalist volunteers as they planned one hour sessions, once each week for four to eight weeks.

First Day Schedule

Arrive early and be prepared with supplies to set the room up. You should have familiarized yourself with the activities you will be conducting prior to this day.

Welcome individuals as they arrive. Attendance should be taken to assist with learning names. When all participants have arrived, introduce yourself. Share something interesting about yourself with the group. Introduce the Explorers Program and briefly mention that you are a volunteer with the Master Naturalist Program, a program sponsored by the Minnesota Department of Natural Resources and University of Minnesota Extension. It is helpful to share basic information about the structure of the program, “For the next six Mondays we will be learning about the outdoors and nature. Each week we will be spending some time outdoors so be sure you dress for the weather.”

Conduct an ice breaker activity to start the day.

Hand out Explorers backpacks, journals, tree cookie name tags, pencils and permanent markers. Have participants put their names on these items. Ask what it means to be an Explorer. Refer participants to page 1 of their journal for what Explorers do and what the rules for Explorers are.

Introduce the Minnesota Weatherguide Environment Calendar by showing the day’s date and the calendar features. Briefly mention that each week participants will be using the calendar to look at average temperature and phenological events. Phenology and the study of seasonal changes can be introduced on the first day.

It is recommended to take a brief hike around the schoolyard the first day. The hike can be used to make basic nature and weather observations.

Wrap up for the day. Ask the participants what they observed outdoors and summarize the topic of the day. Collect backpacks, journals, pencils and name tags. Take materials home with you in the materials bin.

Every Day

Consider bringing in a natural “object of the day” that relates to the topic you will be teaching about. This can be placed at the front of the room for the participants to look at as they come in to see if they can figure out what it is and what they will be exploring that day. Suggestions can be found at the beginning of each main activity.

Welcome participants, take attendance, hand out backpacks, journals, pencils and name tags.

Refer to the Minnesota Weatherguide Environment Calendar for weekly phenology, average temperatures and other relevant information.

ICEBREAKERS

The ice breaker activities are designed to be used at the beginning of each session or incorporated throughout the daily lessons. They can help participants feel comfortable with each other and the leader as well as help transition from the normal school day to the Explorers program.

Nature Makes Me Feel

Have everyone stand in a circle. Explain that each person should start by saying, “Nature and/or being outdoors makes me feel _____” and then respond with an expressive gesture. The leader gives an example, “Being outdoors make me feel HAPPY” and then he/she smiles or “Rain makes me want to jump in puddles” followed by jumping up and down. Adapt question based on the season and/or the current weather. When everyone has taken a turn, you can go around again with a different response.

Who Am I?

Place a name tag with an animal or plant found in Minnesota during the fall on the back of each individual. Participants are only permitted to ask one yes or no question per person about their animal or plant. They can go back through the group a second time and ask one question per person if the group is small or more time is needed. The goal is for the participant to guess the plant or animal on his or her back. This activity can also be done by giving only one participant the name of a Minnesota plant or animal and have the class ask questions to figure out the answer.

Animal Search

Prior to the participants’ arrival, come up with a list of five native Minnesota animals. This number might vary depending on the size of the group. Spread the participants out around the classroom or outdoors. Whisper the name of one of the animals into each participant’s ear. There should be at least two participants with the same animal name. When all players have been named, instruct them to find the rest of their “species” or fellow animals by making the sound or acting like the animal. The activity ends when all animals have found their fellow partners. Examples of animals might include owl, bear, wolf, wild turkey, frog or snake.

NATURE JOURNALING

Adapted from a *Keeping a Journal*, Monarch Lab, University of Minnesota.

Objective

To learn the basics of a nature journal.

Supplies

Explorers' nature journals

Pencils

Thermometer

Minnesota Weatherguide Environment Calendar

Objects of the Day: Examples of nature journals, plant and animal sketches and field guides

Magnifying glass (optional)

Camera (optional)

Background

Keeping records and taking measurements are important to being an Explorer. Good observations come from spending time looking at natural surroundings and making recordings through data collection and drawings. These recordings can be important for short and long term understanding of the environment.

The nature journal can be used to keep track of observed natural characteristics and changes in the environment made through written observations, recorded data and/or drawings. Observations might be based on the senses; sight, smell, touch or recorded data such temperature (actual vs. average), clouds types and wind. The journal is also a tool to record the seasonal phenology and changes around the schoolyard and surrounding neighborhood.

Emphasize that the participants do not need to be expert artists or writers to be good at journaling. Every journal entry is a good entry. Encourage participants to notice as many details as possible. Add labels to the drawings and note details like the date, location and weather. Provide examples of journal entries for the participants either from your own experience or in the Explorers' nature journal to help them get started.

Phenology is the science of seasonal changes and their effect on the natural world. A phenologist is someone who studies the changing of the seasons. Tracking events takes time and patience. First, you have to learn to be a good observer. Second, you have to become an accurate recorder of what you observe. Third, you have to become a critical thinker, finding links among the phenomena you are observing.

Activity

1. Explore and discuss the objects of the day.
2. Ask the participants why it is important to keep nature related records and measurements. What tools and supplies are needed? What would cause us to all have different observations?
3. Encourage participants to practice observation and description skills using words and drawings. Journal prompts are often helpful with weekly entries. Prompts might be sentences or key words that often help to initiate a journal entry. Refer to *Nature Observation* in the Explorers' nature

journal (page 3). The first time the journals are used, take a brief field trip around the schoolyard and record things the participants see. Share the list with each other.

4. One way to practice recording observations is to map the area of the schoolyard that will be visited during the Explorers program. Note key features like buildings, trees or paths. See *Draw a Map of Your Site* in the Explorers' journal for the mapping exercise (pages 4-5). The key can be used to draw symbols such as trees, shrubs or other landscape features to place on the map. The compass rose can be used to label the cardinal directions of North, South, East, and West. A good way to remember the letters and order on the compass rose is Never Eat Soggy Waffles. Consider sharing an aerial map of the schoolyard from a program such as Google Maps to show the participants another perspective of the area. Participants might also select a site in the schoolyard or a tree to observe once a week through the Explorers program. Drawings and photographs may be used to document the changes week by week. Assign a date to each of the recordings.
5. Record weekly weather observations such as temperature and general weather conditions such as precipitation and clouds on the *Weather Tracker* pages in journal (pages 10-11). Clouds may be classified by type or by the amount of coverage – clear, partly cloudy, mostly cloudy or overcast. Ask the participants how making weather observations is different when outside versus looking out the window or viewing photographs. Encourage the participants to compare the weather forecast printed in newspaper or on TV for a particular day with the actual weather conditions. Was the meteorologist accurate? Refer to the Minnesota Weatherguide Environment Calendar as a reference for average temperature data and weekly phenology.
6. Share the information presented in the phenology section of the Minnesota Weatherguide Environment Calendar. It is found after each month's calendar page. Define "phenology" and discuss seasonal changes to watch for in the upcoming month. Show participants the checklist of typical seasonal changes on the *Fall Phenology* page of the Explorers' nature journal and invite them to look for these changes as they go outside (page 7). Participants should observe and record any of the signs of fall in their journals and share with the group.
7. Other questions refer to the season. What are signs of fall? Refer to the Minnesota Weatherguide Environment Calendar and the Explorers' nature journal (page 7). Why it is important for naturalists and scientists to notice as many details as possible? Encourage participants to make general predictions of seasonal phenology. How do fall temperatures and hours of daylight/darkness change as the season changes and what effects do these changes have on plants, animals and weather in the area? What changes happen outdoors when fall arrives, temperatures decrease, etc.? Encourage the participants to observe changes as the seasons change from fall into winter and winter into spring on the *Phenology* page of the Explorers' nature journal (page 6).

Extensions

Constructing a Nature Journal

Objective: To construct a take-home nature journal.

Supplies: Colored cardstock paper, white paper, hole punch, straight stick, and a rubber band.

Activity: Construct nature journal by folding at least five sheets of white paper and place inside a folded cardstock cover. Punch two holes near the folded edge and wrap a rubber band around one end of the stick, guide the rubber band down through the hole then along the back of the journal and up through the second hole. Finally, wrap the rubber band around the other end of the stick. Illustrated directions can be found at www.makingbooks.com/elastic.shtml. The nature journal can be personalized with the participant's name and drawings. Journals can be constructed at any point during the Explorers Program. Encourage participants to make journal entries near the school, neighborhood or favorite outdoor location. Participants are also welcome to add photos to the journal along with a description of the object.

Onion Hike

Objective: To follow a trail using only your sense of smell.

Supplies: Scents that are easy to follow such as an onion. You may also use flavor extracts from the spice aisle at the grocery store.

Activity: Mark out a trail using only an onion or other smells such as mint, anise or vanilla. Rub the scent on trees through the woods. Have participants try to follow the scent. You may consider hiding a treasure at the end of the trail as an added incentive. Ask participants if it was difficult to find the scent. What other scents did they discover? What makes this activity hard or easy? How do animals use their senses of smell in the fall? Have participants mark the scent trail on their Explorers' nature journal map and journal about what they discovered.

Bicycle Spokes

Objective: To challenge the sense of sight and hearing and change participants' perspectives on making observations.

Supplies: None

Activity: Have participants sit in a circle, then scoot directly back and lie down on their backs to form the shape of a wheel with spokes. Be silent for one to five minutes. Ask participants to describe what they heard. How many different sounds did you hear? What proportion of the sounds was non-human? Were you surprised or impressed by anything you heard? What did you see from this perspective? In what ways would you act differently if this was your perspective all the time? How do animals use their sense of hearing to survive in the winter? In their Explorers' nature journals, have participants write about their experiences lying under the tree.

NATURE OBSERVATION BASICS

Objective

To explore the schoolyard using multiple senses and record observations in the Explorers' journal.

Supplies

Explorers' nature journals

Pencils

Objects of the day: Ruler, magnifying glasses or binoculars

Linnaeus List or other field guides (optional)

Background

Making detailed observations of the environment is important to scientists, naturalists and everyday people. Using all the senses can result in a well-rounded understanding of the surroundings.

Every known living organism is classified and named by a set of rules and guidelines. Those rules are used by all scientists around the planet. The names scientists use are called scientific names, not common names.

Common names are the ones you might use when talking with your friends or family. You call your pet a dog or a cat which is the common name. Scientists call those animals by a set of several names like *Felis catus*. That's a domestic cat. Common names for organisms can be confusing because anyone can make them up, and they may apply to more than one species. For example, the mountain lion also has other common names such as panther, cougar, or puma. The scientific name for the mountain lion in North America is *Puma concolor*. *Puma concolor* refers to only one animal.

Scientific names follow a specific set of rules. Scientists use a two-name system called a binomial naming system. Scientists name animals and plants using the system that describes the genus and species of the organism. The first word is the genus and the second is the species. The first word is capitalized and the second is not. A binomial name means that it's made up of two words (binomial). Humans are scientifically named *Homo sapiens*. The name is always in Latin because when this naming process started, most people everywhere knew Latin. Scientific names help scientists to study organisms, especially when working with other scientists since they know which species is being discussed no matter where in the world they may be.

The descriptions used in field guides often refer to the characteristics such as color, size and shape in addition to feeding and nesting habits and the distribution or range of the plant or animal. The range map on the *Field Guide* page can be used to show where the organism is found in Minnesota (page 16).

Activity

1. Explore and discuss the objects of the day.
2. Discuss what tools (if any) are needed to make nature observations. How might the tools assist with making observations?
3. Ask the participants if they have made any recent nature observations.
4. Review the expectations/rules for going outside.

Tips to share with the participants:

- Wildlife is often easily scared by sudden movement and loud noises.
 - Participants should be within view and be able to hear the instructor at all times.
 - Stay on the trails and pathways, unless told otherwise.
 - Walk slowly.
 - Look up, down and all around. If something catches your interest, stop to sketch it or write about it.
5. Refer to *Nature Observation* in the Explorers' nature journal (page 3). Spread the participants throughout the schoolyard. Encourage them to complete the observation page by using their senses. Senses may be used at the same time or you may encourage participants to isolate one sense at a time. Gather the participants together and compare and contrast the lists.
 6. Ask the participants what unusual items they recorded. What sense resulted in the longest list? What sense was the most challenging to use? Encourage the participants to make nature observations when they go home and report their findings at the next gathering.
 7. Refer to the *Field Guide* page in the Explorers' nature journal (page 16). Also show the participants examples of field guides such as the Linnaeus List. Discuss what features help to identify plants and animals and review what information is included in a typical field guide. The field guide page in the journal provides an opportunity for the participant to create an imaginary or real plant or animal. The field guide includes information such as common name, scientific name, description, picture and range map.

Extensions

Closer Look

Objective: To amaze participants with the details not readily observable in nature and to practice using scientific tools.

Supplies: Magnifying lenses or binoculars

Activity: Review how to use the tools and give each individual or pair of participants binoculars or a magnifying lens and allow them to explore. Consider narrowing the focus of a hand lens exploration by challenging participants to discover the smallest living thing or something they never knew existed. Test the binoculars use by asking participants to read words or count something far away. In what ways do these tools help you explore nature? In what ways do they hinder your exploration?

Paint Chips

Objective: To challenge observation skills and increase awareness of nature's many details.

Supplies: Paint sample strips

Activity: Distribute paint sample strips from a hardware or paint store to each participant. Instruct each participant to find a color in nature that exactly matches a color on the paint sample. Did you find an exact match? Is an exact match possible? Why or why not? Were you surprised by how easy or challenging it was to find a match?

Slice of Silence

Objective: To establish a sense of place by using all senses to explore.

Supplies: None

Activity: Have participants find a quiet place to sit alone in a natural area. Give them at least ten minutes to sit and savor the quiet. Discuss the experience: What did you see? Hear? Smell? Touch? How did your experience change as time passed? You may also use blindfolds if available to help participants focus on their senses of hearing. Have participants list the different sounds - natural and those caused by humans. Ask how sounds could be different during different times of the day. With a partner or the whole group, have students share what they noticed when they closed their eyes

FALL WEATHER WATCH

Objective

To determine and record basic weather observations such as cloud cover, precipitation and temperature.

Supplies

Explorers' nature journals

Pencils

Minnesota Weatherguide Environment calendar

Cloud photos/drawings

Thermometer

Objects of the day: Weather page cut from a newspaper, glass jar with frozen water to observe condensation as the ice melts

Background

Meteorologists are scientists who study the weather and the atmosphere. They are best known for forecasting the weather. In this activity, participants will make and record their own weather observations. They will also make connections between changes in the weather and seasonal changes in nature by using the Minnesota Weatherguide Environment Calendar.

High and low temperatures - by recording the daily high and low temperatures throughout the season and comparing them to the rest of the year, participants will see that fall and spring experience greater temperature differences than summer and winter months. By comparing the average temperature for the date and actual readings participants can make seasonal connections and know what kind of weather to expect.

The water cycle is the process through which water molecules move between the atmosphere and the Earth's surface. The main components are precipitation, condensation, evaporation, infiltration, and transpiration.

- Precipitation - moisture, often in the form of rain or snow, that falls to the ground
- Evaporation - when water molecules turn to vapor form and rise into the atmosphere
- Condensation - the opposite of evaporation, when water vapor in the air converts into liquid form
- Transpiration - when plants give off water vapor through tiny pores in their leaves
- Infiltration - the process of water soaking into the soil from the ground level

A cloud is made up of many tiny droplets of condensed water or ice crystals. Clouds help return water to the earth through condensation and precipitation.. Note that the warmer summer months usually result in more variety in cloud types.

A few common cloud types include:

- Cirrus - High wispy, thin clouds spread out high in the sky, horsetails

- Stratus – Clouds in low flat layers, spread out over most or all of the sky, fog
- Cumulus – Big puffy clouds, like giant cotton balls, reduce transpiration and evaporation
- Cumulonimbus – Clouds that can grow very large and tall, often bring rain and storms

The back of the Minnesota Weatherguide Environment calendar and the Explorers' nature journal provide photos of different cloud types. In addition, check out the following websites:

<http://cloudappreciationsociety.org/collecting/> has a helpful diagram of cloud types.

Web Weather for Kids – Clouds: <http://eo.ucar.edu/webweather/cloud3.html>

Activity

1. Explore and discuss the objects of the day.
2. Ask participants what they might typically observe in nature during this time of year. Refer to *Fall Phenology* checklist in the Explorers' nature journal (page 7). Explain that weather can affect how animals behave.
3. Highlight daily weather information along with phenology information for the week found in the Minnesota Weatherguide Environment Calendar. Refer to this information when outside with the group.
4. With the help of participants, draw, label and discuss the main parts of a water cycle including: precipitation, condensation, evaporation, infiltration and transpiration. You can do this on a white board or large sheet of paper or in the Explorers' nature journal (page 8).
5. Discuss the water cycle's connection to weather, the movement of water and ways water moves through the cycle in the fall.
6. Have participants look at the different cloud types in their journals. In addition, show photos in the Minnesota Weatherguide Environment Calendar or copies of cloud photos from websites. Discuss how clouds are formed. Ask where clouds fit in the water cycle. Which type of cloud brings us rain? Thunderstorms?
7. Go outside and have participants lie on their backs to observe the clouds. They can sketch their shapes in their journals. Ask participants how many different cloud types they observed. Are there differences in the clouds depending on the direction you look? Can you predict what the weather might be tonight? What types of clouds do you see? What else do you notice in the sky?
8. Use the Explorers' nature journal *Temperature* page to explain how to read a thermometer (page 12). Have one person from the group determine the actual temperature by looking at the thermometer you brought along. Have participants record the temperature in their journals. As an instructor, you can keep a graph of daily temperatures and average daily temperatures found in the Minnesota Weatherguide Environment Calendar. Together, look at trends across the weeks of the Explorers program. Discuss how changes in temperature can affect organisms.
9. While outside also record wind speed, cloud conditions and precipitation for the day on *Weather Tracker* pages in the Explorers' nature journal (pages 10-11). Compare and contrast conditions from week to week. Also, notice if there is a difference in the number of birds you see or other animal behaviors depending on the various weather conditions.
10. Gather items and head inside. Ask participants to watch the evening weather forecast during the week or review the forecast online then check to see if the meteorologist was correct with the

forecast the following day. When you return the following week, discuss what participants noticed about the forecast during the week.

Extensions

Beaufort Scale

Objective: To understand how to describe wind speed.

Supplies: Copy of Beaufort Scale from www.weatherwizkids.com/weather-wind.htm

Activity: Determine wind speed using the Beaufort Scale which is an empirical measure for the intensity of the weather based mainly on wind power. The wind speed is determined by making basic environmental observations.

Find the Wind

Objective: To determine which the direction the wind is traveling.

Supplies: Container of bubbles

Activity: Since we cannot see the wind participants investigate the direction and speed of the wind using bubbles. Ask if participants can feel the breeze. How can you tell if it is a windy day? Have them look for different signs of the wind blowing (the movement of plants, branches on trees, exhaust in the air, etc.). Make a list of ways to “see” the wind. Now blow bubbles and try to determine which way the wind is blowing. Do the bubbles change direction? When? Why? Are the bubbles moving in the same direction as the clouds? Winds often blow in different directions. Warm air can blow in one direction and cold air in another. Check out www.weatherwizkids.com/weather-wind.htm.

Transpiring Leaves

Objective: To observe leaf transpiration.

Supplies: Plastic bags, twist ties

Activity: Have participants tightly tie a plastic bag over one to three different types of leaves outside. Come back later and notice the condensation on the bag showing that transpiration is taking place. Are the different leaves transpiring equally? Why or why not?

GETTING TO KNOW LEAVES

Adapted from *Variations on a Leaf*, Vermont Institute of Natural Science (VINS) www.VINSweb.org

Objective

To observe the similarities and differences between leaves and understand how they function as food producers for plants.

Supplies

Explorers' nature journals

Pencils

Object of the day: Plant leaves

Magnifying glasses, tree identification guides, crayons (optional)

Background

In most plants leaves are the primary producers of their own food, making them a very important part of the plant. Through a process called photosynthesis, leaves use air, water and minerals to make food. They collect water and minerals from the soil through their roots and carbon dioxide from the air through their leaves. Chlorophyll, a green pigment, absorbs light to provide energy for the process of photosynthesis.

Leaves come in a variety of colors, sizes, textures, and shapes. See *A Quick Guide to Leaf Types* in the Explorers' nature journal (page 19). Leaves can be simple or compound and they may be arranged opposite or alternate from each other on the stem, their edges may be smooth, toothed, doubly toothed or lobed.

In the fall, chlorophyll production stops and often brilliant yellow, orange and red colors emerge. Both the breakdown of chlorophyll and the chemical changes in the compounds in the leaves are triggered by the change in day length. The extent of the chemical change and the brilliance of the resulting colors are related to temperature, moisture and the amount of bright sunlight. Warm sunny days with cool nights create the brightest color.

See www.mndnr.gov/fall_colors/typical_peak.html for additional information on why and where leaves change color in Minnesota.

Activity

1. Explore and discuss the objects of the day.
2. Explain the different shapes and edges leaves by referring to *A Quick Guide to Leaf Types* in the Explorers' nature journal and comparing the drawings to real leaves (page 19).
3. Go outside to an area with a variety of leaf types. Provide ideas for leaves to look for such as a leaf bigger than your hand, smaller than your thumb, with smooth, lobed or toothed edges; unusual texture, or a leaf that has been eaten or partially decayed. Give participants five to ten minutes to collect a variety of leaves from the schoolyard.
4. Bring the participants together and ask them to take a closer look at the leaves collected. Which leaves have a protective coat or waxy texture? Waxy coatings encourage water to drip off and fuzzy coatings help to keep moisture in. Did you find leaves with edges that are smooth, toothed, doubly toothed and lobed?

5. Encourage the participants to attach their favorite leaf in their Explorers' nature journals or make a leaf rubbing on the *Leaf Observation* page of their journals (page 23). With the underside of the leaf up, place the paper over the leaf and rub gently with crayons or edge of the pencil tip.
6. If time, encourage participants to sketch a leaf on *How to Draw* (page 24). Next, have participants draw a leaf they found outside and ask a partner to pick out the leaf sketched from a pile of assorted leaves.

Extensions

Collecting Leaves

Adapted from *Teachers' Guide to Arbor Month*, Minnesota Department of Natural Resources

Objective: To preserve leaves for future observation.

Supplies: Newspaper, books, cardboard

Activity: Collect leaves and then place them between sheets of newspaper. Put the leaf-filled sheets inside large books or between cardboard and place bricks, books or other heavy objects on top. Change newspaper regularly to absorb water better and prevent mildew. When dry, press leaves between wax paper with a warm iron.

A Special Place Through the Seasons

Objective: To observe the seasonal changes in one particular place.

Supplies: Explorers' nature journals, pencil, digital camera (optional)

Activity: Select a special place in the neighborhood or special tree and take a photograph or make a drawing during each season of the year. Record the dates in a journal along with photographs or drawings. Describe the changes noticed throughout the year in and around the area selected. Consider making journal entries more than one time during each season.

SEEDS ON THE MOVE

Adapted from *Seed Dispersal*, Vermont Institute of Natural Science (VINS) www.VINSweb.org

Objective

To understand the different ways plants disperse seeds to new locations.

Supplies

Explorers' nature journals

White board or paper

Object of the day: Variety of seeds with different dispersal methods

Magnifying glasses (optional)

Background

Unlike animals that can walk around, find a mate and then have their young, plants are basically restricted to one location. How is it that they are able to reproduce and spread without being able to move?

One of the ways plants spread is by the production of seeds. Most flowers have male and female parts. Pollen is produced by the male part of one plant and fertilizes the ovule or female part of another like plant. Pollen is transferred from one flower to another by the wind, insects, hummingbirds and sometimes bats. When a flower is pollinated, the ovule begins to change and matures into a seed. A helpful diagram can be found at <http://pollinator.org/beeissues.htm>.

Most seeds are formed inside a fruit. Even foods we think of as vegetables like green beans or peas are considered fruits by botanists because they have seeds. Most seeds have a hard covering so they can survive without soil or water for an extended period of time. Some seeds, like raspberries and blackberries, have to be eaten by animals in order to sprout. The acid in mammals' stomachs help break through the hard outer coating. Other plants need fire to disperse the seeds. Cones of jack pine trees open when heated in a fire, dropping the seeds. Some seeds can survive over a hundred years before spouting like moth mullein. The plant will not spout until conditions are just right.

In order for seeds to find those "just right" conditions they need to get to just the right place. Seeds are dispersed through a variety of methods and include the following examples:

- Wind - The helicopter-like blades of maple seeds help move the seeds away from the parent tree. The silky white tufts of dandelions and milkweed seeds act like parachutes.
- Animals - Spines, hooks and barbs help seeds like burdock to hitchhike on fur, feathers and clothes. Some seeds have sticky substances that cling to passing animals. Uneaten buried caches or collections of seeds and nuts made by mice, squirrels, chipmunks and some birds develop into plants. Seeds inside fruits such as berries and apples are eaten by animals and then pass through the animals' droppings.
- Dropped or tossed by plants - Touch-me-not (jewelweed), wild lupine and pea plant all toss their seeds when pods explode. Acorns and pinecones fall from trees.
- Water - Water lilies, cattail and other aquatic plants often use water to disperse seeds.

www.mndnr.gov/young_naturalists/seeds/index.html has helpful illustrations.

Activity

1. Explore and discuss the objects of the day.
2. Using a whiteboard or other drawing surface, show how a flower is pollinated and a seed is formed. Ask participants what kind of seeds they eat.
3. Explain that seeds are dispersed so that not too many are in one area; this often happens in late summer or fall. Explain that seeds are spread in four main ways; by the wind, animals, dropped or tossed by the plant itself and water. Show or draw examples of each. Dispersing seeds away from the parent plant increases seeds' chances of survival. If all seeds fell around the plant and grew up around the parent plant they would choke each other out. See *Seed Dispersal* in the Explorers' nature journal (page 14).
4. Divide the participants into pairs or small groups.
5. If you are allowed to collect at the site, use the Explorers' nature journal *Seed Collection* (page 15) and ask participants to search the schoolyard to record and collect seeds that match the following criteria:
 - seeds that travel at least one meter (arms spread wide) when you blow on them
 - seeds that stick to clothing or the fur coat of an animal
 - seed head with at least twenty seeds inside
 - seeds that are hard and have a thick coat
 - a super tiny seed
 - a seed inside a fruit
6. Gather participants together to share at least one type of seed that they found. What criteria did it match? What type of dispersal method did it use? What type of dispersal method seemed most common? Why?
7. Have participants look for seeds around their homes and bring in a few samples to the next Explorers meeting.

Extensions

Milkweed Seed Race

Objective: To observe how wind-dispersed seeds move differently from other seeds.

Supplies: Milkweed or other wind-dispersed seeds and dried beans from the grocery store

Activity: Collect milkweed seeds (or other wind traveling seeds) and distribute a few per participant. This can be done ahead of time or as a group. From a designated spot or line have one to three participants throw their seeds into the air. Measure the distance the farthest seed goes before touching the ground and mark the spot with a rock or other heavy object. Repeat with dried beans. Which seed went the farthest? Why? Repeat activity but allow the participants to blow on their seeds. Did the seeds travel farther than last time? Why or why not?

Just the Facts, Ma'am

Objective: To be able to make detailed observations to describe an object.

Supplies: One natural object per person, Explorers' nature journals and pencils

Activity: Give participants natural objects such as rocks, sticks, pinecones, etc. Instruct them to write twelve different ways to describe their object. They should be as precise and detailed as possible. When everyone is finished, place natural objects in the center of the group. Have one person take a list and read one description at a time. The group should try to guess which object is being described. Try to match all description lists with their respective natural objects. Why was it easy to guess some objects, harder to guess others? Was it difficult to come up with twelve descriptors for your object?

Seed Engineer

Objective: To design an imaginary seed that will successfully be dispersed.

Supplies: Explorers' nature journals and pencils

Velcro was conceived in 1941 by the Swiss electrical engineer George de Mestral. He examined the burrs from a burdock plant that were caught in his dog's fur. It took fourteen years from conception to patent. Design and draw your own imaginary seed and engineer how it would move. Explain how it travels. What kind of products could this seed be used for? Are there other inventions that could be developed based on the design of your seed?

LEAF LITTER SEARCH

Objective

To identify organisms and materials found in leaf litter samples and describe how decomposition adds nutrients to the soil.

Supplies

Identification guides

Magnifying glasses

Explorers' nature journals

Plastic sandwich bags, drinking cups or other small containers to collect material

Rulers

White paper or container (optional)

Object of the day: Leaves that are partially decayed or have been eaten by critters in leaf litter

Background Information

Leaf litter, dead leaves, sticks and bark that fall to the ground, can be abundant with tiny living organisms such as bacteria, insect larvae, centipedes and mites. Many of these organisms act as decomposers, breaking down leaves and organic matter into humus. Others may be scavengers and feed on dead animals. Regardless of the food they eat, most organisms living in the soil are invertebrates, meaning they do not have backbones. Although small and less noticeable, there are more invertebrates in the world than vertebrates, both in total number and in species diversity.

- Decomposer/decomposition - organism whose role in the food web is to break down the remains of other living things so they can return to the environment and be used/the act of breaking down into basic parts;
- Scavengers - eat dead matter but are opportunistic in their feeding strategy
- Omnivores - eat both plants and animals
- Herbivore - eat plants and other producers
- Carnivores - eat other animals
- Leaf litter - organic matter found on forest floor
- Producer - organisms that can produce their own food most through the process of photosynthesis
- Consumer - organism which must consume other organisms to get their nutrients
- Soil - substance containing both small rock particles and decaying organic matter

Activity

1. Explore and discuss the objects of the day.

2. Begin by defining leaf litter. Have the participants predict what they might find during a leaf litter search.
3. Locate an area of the schoolyard to search the leaf litter for living and non-living things. Divide the participants into smaller groups or pairs. String or rope may be used to define a specific area for participants to investigate.
4. Once the search area is defined, ask the participants to carefully explore and remove items, especially critters, from the leaf litter. These items may be transferred to a container or placed on sheet of paper for further investigation. Use *Leaf Litter Critters* to record participants' findings (page 22). Leaf litter can be collected ahead of time and brought inside the classroom in case of rain or if not available at the site.
5. Ask participants what they found. Where did it come from? Was it eating something? What might eat the critter you found? What role does it have? What features make your critter interesting? What happens to the leaf litter at the end of the fall season? Consider counting the critters found. Return all items to the location where they were found at the end of the activity.
6. Discuss what happens to leaves that fall to the ground each fall and why the forests do not fill up with dead leaves. Ask the participants to describe items that have or are beginning to decay. Further discuss and explore the concept of nature recycling and composting.

Extension

From Leaf Litter to Topsoil

Adapted from *Schoolyard, Ecology and Exploration*, University of Minnesota.

Objective: To understand factors that affect decomposition.

Supplies: Clear plastic bags, leaf litter, top soil, cardboard or wood

Activity: Prepare two plastic clear bags, one with leaf litter and one with top soil. Ask participants what the two bags have in common. Point out that over time the leaf litter will become topsoil and that soil contains living organisms. Discuss what factors affect decomposition rates: moisture, presence of decomposing organisms, time, temperature and surroundings (under pine tree, wetland or on an open lawn).

Study life in the schoolyard by placing a piece of cardboard or piece of wood in a remote area. Leave this on the ground and then observe week by week what is living underneath. Check with school and facilities management to make sure placing these items in the schoolyard for an extended period of time is acceptable.

Consider placing small amounts of food such as pieces of apple, carrots, dog or cat food in an area and study what animals visit the area. How long does it take the food to disappear? How does this help demonstrate the importance of the earth's clean-up crew?

INTRODUCTION TO A TREE

Objective

To understand how to observe and record the different types of trees growing in the schoolyard and compare their characteristics.

Supplies

Explorers' nature journals

Pencils

Magnifying glasses

Rulers

Branches with both opposite and alternate arrangements as well as buds

Tree cookie name tags, large tree cookie or photo of tree cookie

Objects of the Day: Deciduous and coniferous tree branches with buds and/or leaves

Tree field guides (optional)

Background

Trees can be found on most schoolyards and are a great way to watch the season progress as daylight gets shorter. The main part of this activity will occur on the first visit but throughout the weeks make sure to take a little time every session to have participants observe their trees, looking for any changes and noting them in their journals.

There are two main types of trees. In general, deciduous trees lose all of their leaves in one season and coniferous trees keep their sharp and narrow leaves called needles on the tree year-round. Coniferous trees produce cones that carry their seeds. In fall, deciduous trees begin to shed their leaves to conserve energy and limit damage to the tree from the snow and storms during the winter.

Many people think you can't tell trees apart once the leaves have fallen off. However, by closely examining the buds and bark, you are often able to identify trees.

The main parts of the inside of a tree include:

- inner wood - supports the tree, stores growing compounds and sugars
- xylem - carries water and minerals from roots to leaves
- cambium - makes trunk, branches and roots thicker
- phloem - carries food (sap) from leaves to rest of tree
- outer bark - dead tissue that protects the tree from injury (much like human skin).

More information can be found at www.mndnr.gov/forestry/education/treeforallseasons/index.html

Activity

1. Explore and discuss the objects of the day.
2. Ask participants how they might identify trees in the fall. Make a list of tree features that may be helpful in identification: height, diameter, bark texture, leaves, shape, etc.

3. Point to a tree or show a fall tree photo and ask participants to make some general descriptions. How might those features change in the spring, summer and winter seasons? How many different kinds of trees do they think they will find on the school grounds? Have them write their predictions in their Explorers' nature journals.
4. Show and discuss the differences between a deciduous and coniferous tree.
5. Open to *Leaves and Branches* in the Explorers' nature journal (page 18). Using real branches, show the difference between an opposite and alternate branch and have participants make a quick sketch of each in the appropriate circle. Then show at least two different kinds of leaves and have participants sketch one in the bottom circle.
6. Have participants predict the number of kinds of trees in the schoolyard and write it in their journals. Go outside and give participants five to ten minutes to find and count as many different species (not numbers) of trees as they can within the boundaries you set. When time is up call them back in and have them write their answer in the Explorers' nature journals. How close were they to their predictions?
7. Group participants in pairs and have them select a tree to adopt in the schoolyard. Pass out rulers and magnifying glasses for participants to make detailed observations.
8. Ask participants to record and sketch their tree on a *Nature Observations/Field Sketches* in their Explorers' nature journals (pages 23 - 26). They should include leaves or buds (color, shape, size, and other observations), bark (color, shape, size, and other observations), tree height and shape and any other observations. Make sure participants write down the date of their observations. If they have made a map in their journal of the schoolyard add the location of their tree to this map (pages 4-5).
9. If time, include other observations like: what does the tree smell and feel like? What signs are there that animals have used the tree? Do a bark rubbing. Determine the circumference (C) around the tree. Using a flexible tape measure, measure to the nearest inch the distance around a tree at a point 4½ feet up from the ground (C). Then convert this number into the tree's diameter (D) using one of these formulas $D = C \times .3183$ or $D = C/3.1416$.
10. Take a few minutes every week to have participants revisit their tree and record any changes they see.
11. Gather participants together and return to the classroom. Using their tree cookie name tags refer to the *Inside a Tree* page and review the different parts, how to pronounce them and what they do (page 17). Could they see any of these parts on their tree? Why or why not? Do they think the phloem is active now? Why or why not? What about the xylem?
12. Ask participants to notice the different trees that they see on their way home or when traveling to other places.

Extensions

Know Your Branch

Objective: To recognize characteristics of tree branches by touch.

Supplies: One branch for each participant, blindfolds (optional)

Activity: Place a stack of branches on a table or the floor. Ask each participant to be blindfolded or close his or her eyes and find a branch. Once each participant has a branch, ask them to get to know the branches by feeling and recognizing characteristics like length, branching or texture. Place the branches back in the middle, have the participants take the blindfolds off and then find the branch they were holding. The branches can be a mix of deciduous and evergreen species, shapes and sizes.

Connect the Branches

Objective: To closely observe tree branches and pay attention to all characteristics.

Supplies: Pairs of branches

Activity: Before the Explorers session, cut branches of several different tree species in half. Assign one branch to each participant and ask him or her to find its match in the classroom by using clues like color and texture of bark, branching, buds, shape or size.

Meet a Tree

Objective: To identify trees using senses other than sight.

Supplies: Blindfolds

Activity: In groups of two or three, participants blindfold one member of their group and carefully lead the person to a tree. The blindfolded person gets to know the tree by feeling, smelling, listening to it, feeling for the tree's neighbors, etc. When the blindfolded person is confident that he or she knows the tree, the rest of the group leads the blindfolded person back to the starting point. After removing the blindfold, the newly sighted person attempts to relocate his or her tree. Rotate jobs until everyone has had a turn. Were participants able to find their trees? How did participants identify their trees? How are some trees different from other trees?

Tree Height

Adapted from *Teachers' Guide to Arbor Month*, Minnesota Department of Natural Resources

Objective: To estimate the height of a tree using ratios.

Supplies: Twelve inch ruler, masking tape, measuring tape

Activity: Height is the hardest tree measurement to obtain. Use a ruler and follow the instructions below to estimate the height of trees in the schoolyard.

1. On a 12-inch ruler, mark the 1-inch and 10-inch lines with masking tape.
2. Work in pairs to measure height.
3. Person A stands at the base of the tree.
4. Person B, while holding the ruler up in front of their eyes at arm length, moves back until they can see the whole tree from top to bottom between the 0-inch and the 10-inch mark on the ruler.
5. Person B then moves the ruler until the base of the tree is exactly at 0-inches and the top of the tree is sighted exactly at 10-inches.
6. Person B sights out from the ruler's 1-inch mark to a point on the trunk above the base.

7. Person A marks this spot on the trunk with tape.
8. Measure the distance from the base of the tree to the 1-inch mark (X) on the tree.
9. Multiply by 10 to get an approximate height of the tree.

CAMOUFLAGE AND ADAPTATION

Adapted from *Toothpick Prey, Monarchs in the Classroom: An Inquiry-Based Curriculum for Middle School*, University of Minnesota

Objective

To understand how camouflage increases an organism's chances of survival.

Supplies

One box (100-200) of assorted colored toothpicks or toothpicks that are colored with marker. Tri-colored rotini or spiral pasta noodles or pieces of yarn can also be used.

Outdoor grassy area

Watch

Explorers' nature journals

Pencils

Object of the day: Example of camouflage cloth or photos of animals that use camouflage

Background

Plants and animals have adaptations that help them to survive. An adaptation is defined a characteristic of an organism or ability that helps it survive and reproduce in its environment with its given genetic characteristics. One important adaptation is the organism's ability to blend in with its environment. This is called camouflage. This causes difficulty for predators in finding their prey because the prey is hidden within the colors of the environment. Many animals have colors or markings on their feathers, fur, scales or skin that allow them to blend in with their habitat (where they live). Some examples of camouflage are a green frog hiding at the edge of a wetland, the drab brown feathers of most nesting female birds, winter color of snowshoe hare, etc.

Sometimes the coloration of an animal or pattern does the opposite of camouflage. Instead, its markings or colors call attention to the animal. Colors may issue a warning to other species, or may attract members of the opposite sex of the same species (the bright colors and pattern of the wings of Monarch butterfly, the bold color on skunks; the bright showy feathers of the male wood duck).

Activity

1. Explore and discuss the objects of the day.
2. Scatter an equal number of several different colors of toothpicks or other colored objects on a defined area of grass in the schoolyard.
3. Tell the participants that they are going to be scientists and study predation by finding toothpicks in the schoolyard. They will be bird predators finding insects represented by toothpicks. Do not tell the participants that the toothpicks are different colors, only that they will have 30 to 60 seconds to pick up as many toothpicks as they can.
4. When they are ready, tell the participants to begin and start the timer.
5. After time has run out, have participants count the number of each color toothpick that they collected and record these numbers in the Explorers' nature.
6. Total the number of each color of toothpick collected by the entire class and have the participants record this in their journals. Calculate the percentage of toothpicks of each

color left after predation. Compare the number of gathered versus the original number of each color. To calculate the percentage of all the toothpicks found by the class, divide the number that were found by the total number that were hidden in the schoolyard, and multiply this by 100.

7. Ask the participants: What colors were found more easily and why? What colors were more difficult to find? What would happen if we tried this activity at different times and in different areas: when the grass is brown, if the toothpicks were spread out on the asphalt or in a natural area? How does camouflage change with the seasons?
8. Pick up all remaining toothpicks.

Extension

Find a Pencil

Objective: To build observation skills and appreciation for camouflage.

Supplies: Pencil

Activity: Set boundaries and have participants line up along one edge of the playing area, facing away from the area. While the participants have their eyes closed, the leader hides a pencil anywhere within the playing area. Once the pencil is hidden, the participants may look for it. If a person finds it, he or she should not give away (1) where the pencil is, and (2) that he or she knows where it is. Upon finding the pencil, the player should slowly, nonchalantly return to the starting line and act as overtly cool as possible. When most of the participants have found the pencil without giving its location away, the facilitator should have the group point the pencil out for the remaining lookers. Repeat several rounds, hiding the pencil in harder places each time (on top of the leaves, behind the teacher's ear, stuck in a tree, tucked in the leader's shoe, etc.) Why was the pencil hard to find? What does this tell us about how careful our observations really are?

Habitat I Spy

Objective: To understand how plants and animals may blend in with their surroundings.

Supplies: None

Activity: One participant at a time will be "it." The person who is "it" will look around the room or outdoor area and choose one object that may be difficult to see but does not reveal what the object is. He or she will then give one clue by saying "I spy with my little eye, something that starts with _" and give the first letter of the mystery object. The rest of the participants may ask yes or no questions one by one to try to figure out what the mystery object is. If a participant correctly guesses the mystery object, he or she will be "it" next.

NATURE BINGO

Objective

To explore the schoolyard using a nature bingo card.

Supplies

Explorers' nature journals

Pencils

Field identification guide (optional)

Background

Nature bingo encourages participants to summarize what they observed over the past several weeks. Nature bingo is a good way to wrap up the seasonal Explorers Program.

Activity

1. A bingo card is included with the Explorers' nature journal (page 20). As an alternative, each square of a blank bingo card can be filled in with items that the participants have observed throughout the program. Include a variety of plants, animals and other natural features of the schoolyard. The images of the items can be copied from clipart or the text/name can be included and the participant can sketch each item found.
2. Before going outside review each of the items included on the bingo card.
3. The goal is to get bingo (five squares in a row) or blackout (all spaces crossed off) on the card.
4. Review nature bingo items that were found and not found in the schoolyard.
5. Ask the participants to suggest items for future bingo cards that were not listed. Small prizes/treats could be provided for those who get bingo.

Extension

Question Trail

Adapted from *Exploring The Outdoors With Aldo Leopold*, Pheasants Forever.

Objective: To improve observation skills and practice formulating testable questions.

Supplies: Blank tags with string, pencils

Activity: Give each participant a tag and a pencil. Allow them to wander along the trail and come up with a question about something they see. Do not allow simple questions like, "What is this called?" but instead encourage more investigative questions such as, "Why is this bark different on the branch than on the trunk?" "How did this cob of corn end up in the woods?" "How did this squirrel die and what will happen to it?" When participants come up with a question, they should write the question on the tag and hang it from the questioned object or nearby.

Then, gather all participants at the head of the trail and walk down the trail addressing one question at a time. At each tag, facilitate a discussion on how to make the question listed into something they could test or investigate.

EXPLORERS SCAVENGER HUNT

Objective

To explore the schoolyard for a variety of natural and human-made items.

Supplies

Explorers' nature journals

Pencils

Activity

1. Refer to *Scavenger Hunt* in the Explorers' nature journal (page 21), for items to find around the schoolyard.
2. Review and discuss each item before going outside.
3. Record in writing or with a sketch the items found around the schoolyard and surrounding area.
4. When done searching, ask the following questions: What are some additional items not included on the scavenger hunt form? What things are alike? Which ones are different?
5. Refer to the activity *Nature Observation Basics* for more ideas on making observations.

Note: Other items to include on the scavenger hunt might be something: green, with needles, twisted, curly, round, sticky; a seed, tree bark on the ground, feather, pinecone, something flat, something smooth, rough, red, a flower, leaf, dead twig, weed, or ant. Also, ask participants to compare two different areas such as a sidewalk/paved area to grassy/natural area. List the things that are similar and different between these sites.

Extensions

Nature Alphabet Search

Objective: To search nature items and find each letter of the alphabet.

Supplies: Digital camera (optional), Explorers' nature journals, pencils

Activity: This activity can be completed as a group or individually. Groups and individuals can be assigned groups of letters (i.e. A-F, G-L, M-R, S-Z) to search for. The 26 letters of alphabet can be printed on a sheet of paper to assist with the activity. Provide examples of what different letters might look like in nature before going outside. For example, a branched twig might look like the letters V or Y. The nature letter can be captured with photos or the participants can sketch the items in their journals. Ask which letters were easy to find? Are there common patterns and shapes found in nature?

Scavenger Hunt with a Twist

Objective: To foster reflection on scientific objectivity.

Supplies: Value-laden words on index cards

Activity: Give each participant a card with a value-laden word such as gross, unnecessary, special, or valuable and instruct him or her to find something in nature which their word describes. Show your

finding to the group and explain why this object is described by your word. Were there participants who couldn't find something for their word? Does everyone agree with everyone else's choices? To what extent do our values predict and/or dictate our actions? What impact do our values have on how we view nature? How can you, as a scientist, remove human values from your descriptions of nature? Should you?

Nature Wristband

Objective: To create a wristband of natural items collected from the schoolyard.

Supplies: Tape (masking tape, duct tape or packing tape), natural items like small rocks, seeds, small leaves, pine needles, flowers, sticks, etc.

Activity: Measure around the participant's wrist and cut a piece of tape slightly larger than the wrist to fit over the hand. The tape needs to be sticky side out. Identify an area outside to collect natural items to stick to the wristbands. Do not stick live insects to the wristband. Try to find items on the ground versus picking them off plants. Ask the following questions: What did you find? Where did the items come from? Compare the wristbands and look for similarities and differences in natural items found. Encourage the participants to make a nature wristband at home and compare it with the one they just made.

Note: Natural items can be collected prior to class and this activity can be completed indoors.

REFERENCES

Jeffers Foundation. (2010). *Ecotime: Integrating Environmental Education*. Prior Lake, MN: Jeffers Foundation.

Leopold Education Project. (2009). *Exploring the Outdoors with Aldo Leopold*. Pheasants Forever.

Minnesota DNR Division of Forestry. (2002). *Teacher's Guide to Arbor Month: Activities on Trees and the Natural World for Grades K-8*. St. Paul, MN: Minnesota DNR.

Monarch Lab, University of Minnesota. *Keeping a Journal*. Retrieved on January 20, 2015 from http://monarchlab.org/images/uploads/curricula/Keeping_a_Journal_LC36.pdf.

Oberhauser, K. & Goehring, L. (1999). *Monarchs in the Classroom: An Inquiry-Based Curriculum for Middle School*. St. Paul, MN: University of Minnesota.

Strauss, A.L., Homayoun, T., Meyer, R., Nippolt, P.L., Oberhauser, K., Peterson, C., Rager, A. & Young-Isebrand, E. (2015). *Driven to Discover: Facilitator's Guide to Citizen Science*. St. Paul, MN: University of Minnesota Extension

Young-Isebrand, E. & Oberhauser, K. *Schoolyard Ecology Explorations: an Inquiry-Based Curriculum*. St. Paul, MN: University of Minnesota.

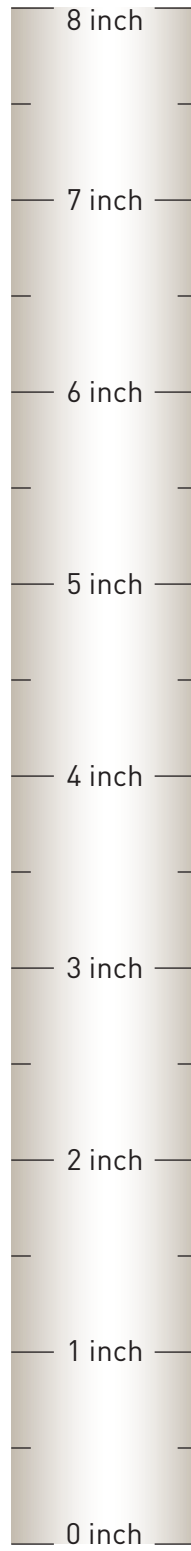

COOL SPRING FACT

The saying "April showers brings May flowers" holds true. April has on average 11 days with rain.

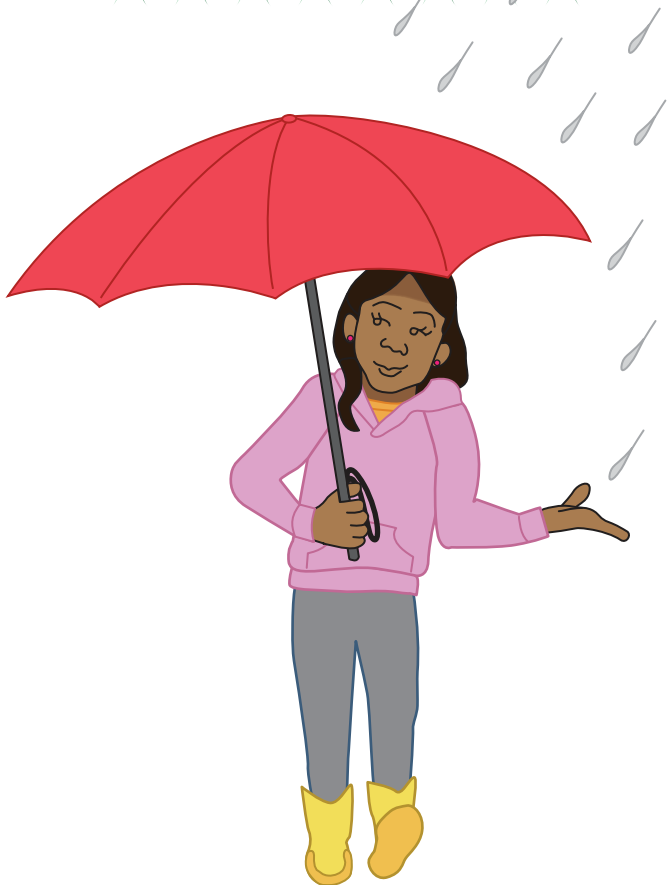

MINNESOTA MASTER NATURALIST

UNIVERSITY OF MINNESOTA
EXTENSION



MASTER NATURALIST EXPLORERS

Spring Nature Journal



Name _____ Date _____

The Minnesota Master Naturalist Explorers Program connects adult volunteers with youth in an after-school setting. The goal of the Explorers Program is to offer fun, outdoor, science-based educational opportunities for elementary students to learn about the ecology and natural history of their schoolyard, neighborhood, nearby natural areas, and the entire state.

Explorers is a component of the Minnesota Master Naturalist Program whose mission is to promote awareness, understanding, and stewardship of Minnesota's natural environment by developing a corps of well-informed citizens dedicated to conservation education and service within their communities.

Acknowledgments

Authors: Dawn A. Flinn, Minnesota Department of Natural Resources; Darren Lochner and Robert B. Blair, University of Minnesota Extension

Reviewers: Bev Blomgren, Pete Cleary, Sara Aker

Designer: Amy Beyer, Minnesota Department of Natural Resources

Funding for this project was provided by a grant from the Minnesota Environment and Natural Resources Trust Fund.



© 2015, Regents of the University of Minnesota. All rights reserved. Send copyright permission inquiries to: Copyright Coordinator, University of Minnesota Extension, 405 Coffey Hall, 1420 Eckles Avenue, St. Paul, MN 55108-6068. Email to extcopy@umn.edu or fax to (612) 625-3967.

University of Minnesota Extension and Minnesota Department of Natural Resources provides equal access to and opportunity in its programs, facilities, and employment without regard to race, color, creed, religion, national origin, gender, age, marital status, disability, public assistance status, veteran status, sexual orientation, gender identity, or gender expression. This material is available in alternative formats upon request.

Answers

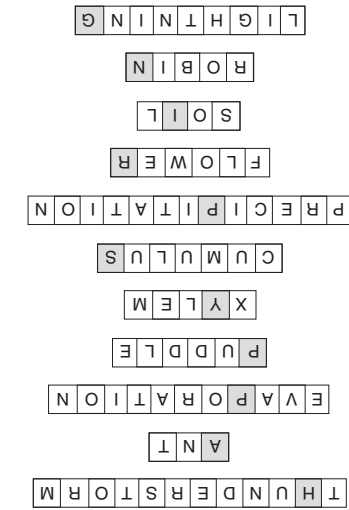

Spring Word Scramble Answer page 18

Bird Migration Answer page 14
Common Nighthawk

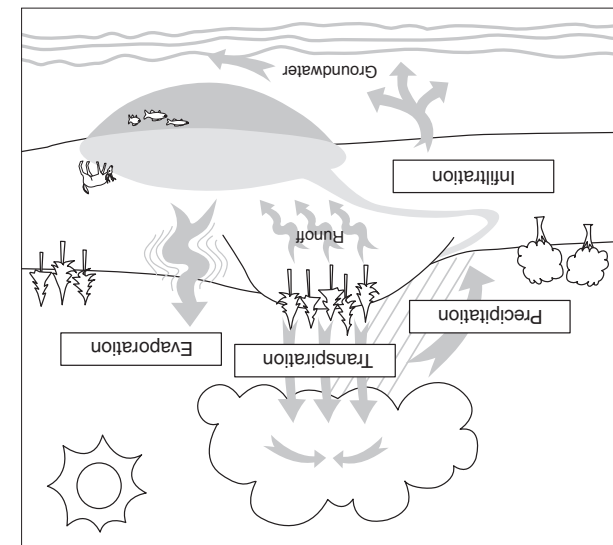

Water Cycle Answers page 8

Vocabulary Words

phenology – the science of seasonal changes and their effect on the natural world

journal – notebook or binder used to make recordings, drawings, and write thoughts and reflections

precipitation – moisture, often in the form of rain or snow, that falls to the ground

evaporation – the process of water molecules condensing and rising into the atmosphere

condensation – the opposite of evaporation, when water vapor in the air converts into liquid form

transpiration – when plants give off water vapor through tiny pores in their leaves

infiltration – the process of water soaking into the soil from the ground level

parent material – the main materials such as rocks and minerals that soil is formed from

subsoil – the soil lying immediately under the topsoil

topsoil – the layer of soil on the surface, often the most fertile and composed of higher amounts of organic matter and microorganisms

ephemeral plants – plants that emerge quickly in the spring, bloom, go to seed, and then die back to the underground root system

COOL SPRING FACT

Minnesota's latest spring freeze is usually around April 29 in the metro and June 1 in the far north.

Introduction

Who is a Master Naturalist Explorer?

It is someone like YOU! A kid who is interested in nature, wants to learn more about it, and have fun exploring the outdoors.

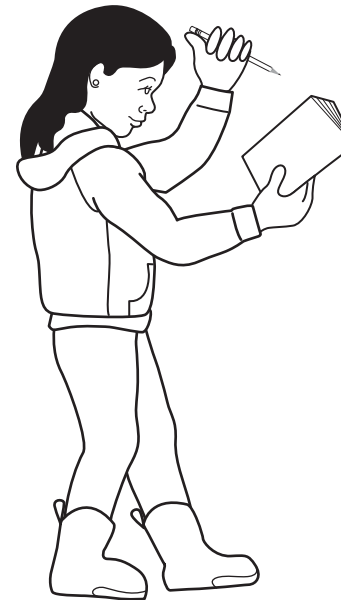
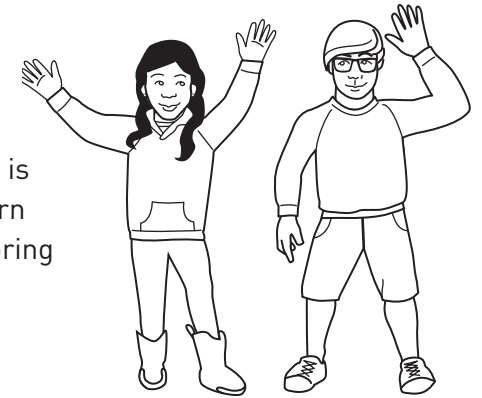

Please do the following:

Be safe.

Be respectful of each other and nature.

Have fun!

What is a nature journal?

A nature journal is a booklet that helps you capture your experiences in nature. It is a place to write, sketch and record your personal observations and thoughts about nature. It is a great way to keep track of your discoveries over time.



Minnesota Biomes

In general, a biome is a large area of land with the same type of plant communities.

Put a star on the map to mark the location of your Explorers program.

What biome are you in? _____

COOL SPRING FACT
Minnesota comes from the Dakota Indian name "Minisota," which means sky-tinted water.

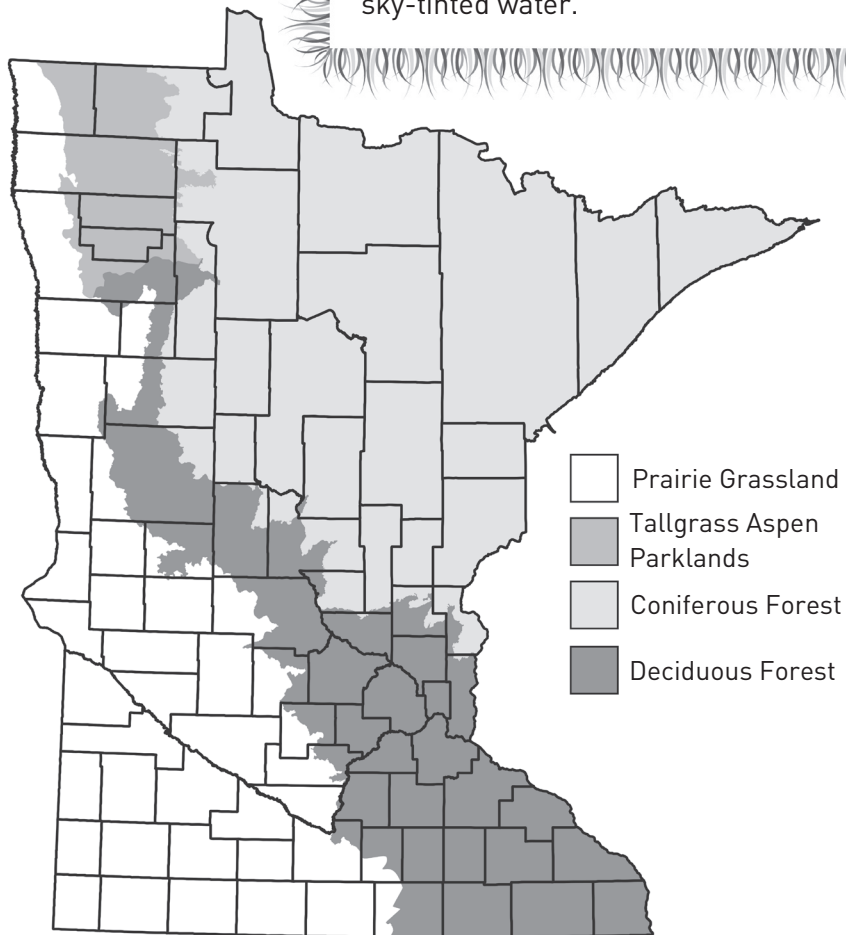

I Promise I Will Help Nature by:

Signature _____



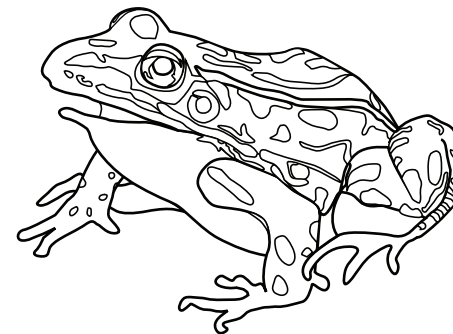

Date _____



Nature Observations/Field Sketches

Nature Observation

Explore your site. Write or draw your nature observations in the boxes below.

 I see	I feel 
I smell 	I hear 

COOL SPRING FACT
Spring peepers can be heard in March, one of the earliest callers among the dozen frog species found in Minnesota.

Draw a Map of Your Site

Create a birds-eye view map of your Explorers program site. Draw in large items such as buildings, playgrounds, streets, grassy areas, trails, forests or gardens. Create a key to identify major features.

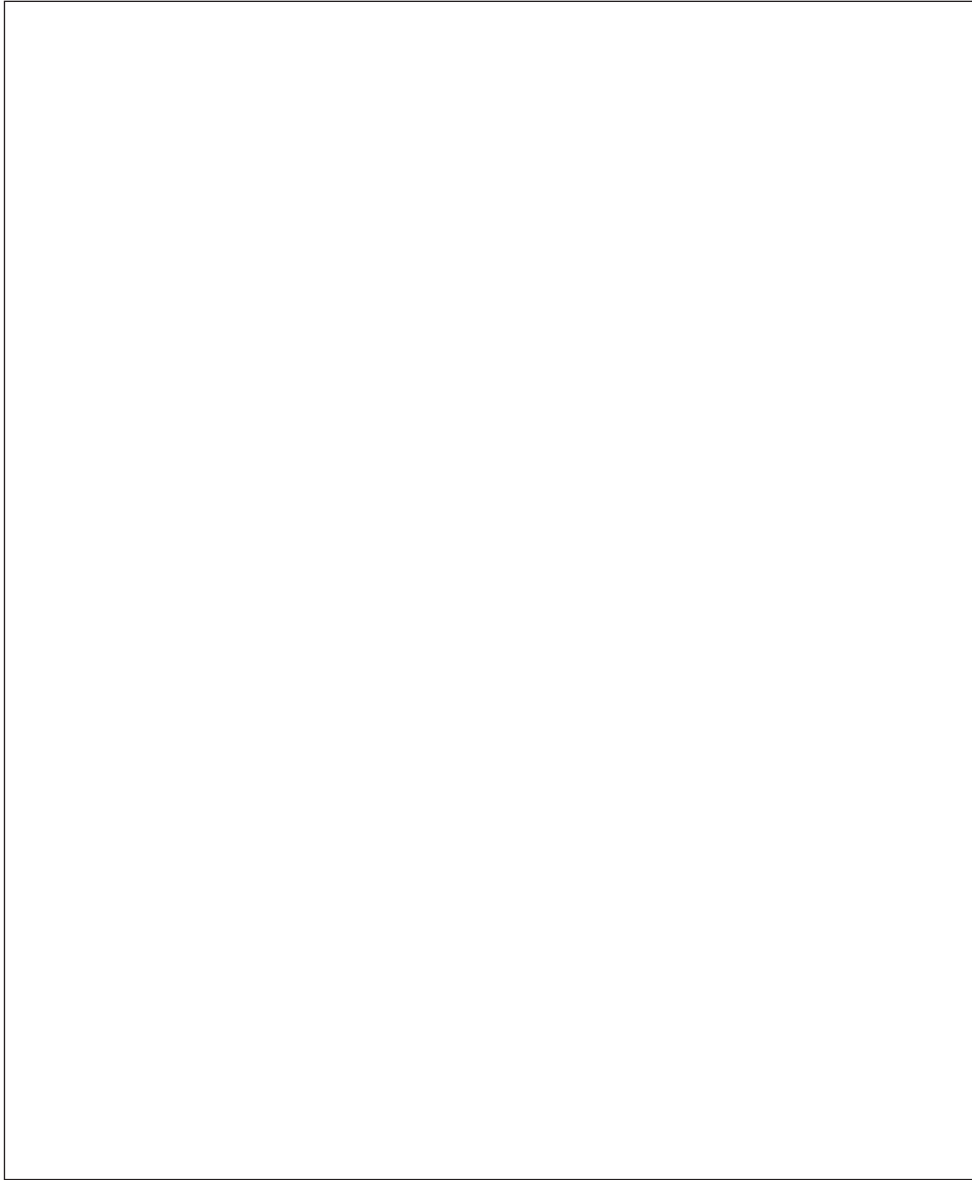

Nature Observations/Field Sketches

How to Draw

Take one step at a time to draw a daisy or a flower of your choice.

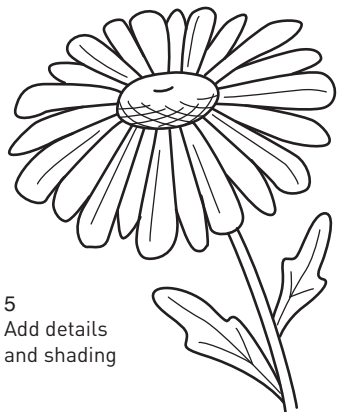
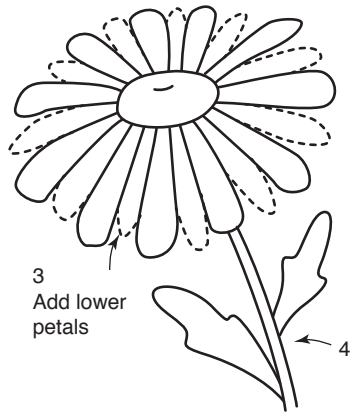
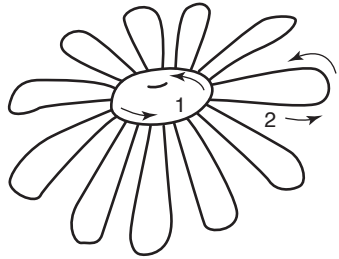

5
Add details
and shading

Key



Phenology

Phenology is the science of seasonal changes and their effect on the natural world. In the squares draw and/or write natural things that may be happening in the different seasons.

Spring	Summer
Fall	Winter

COOL SPRING FACT

March 20, the first day of spring, is called the vernal equinox and is Latin for spring equal night.

Search for Insects

Get to know some of the insects found in your area. Ants, moths and butterflies are common insects that you might find at school or in your neighborhood. A few common features of insects include: six legs along with a head, thorax, and abdomen body parts.

Ant

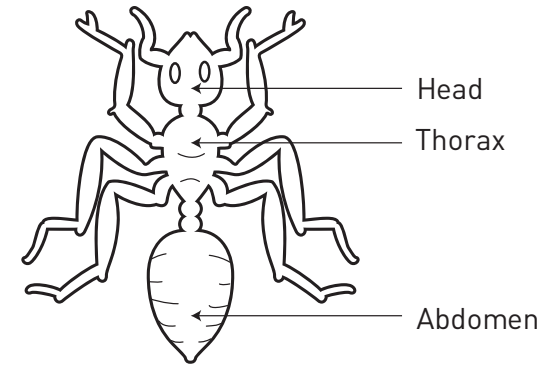

Fritillary Butterfly

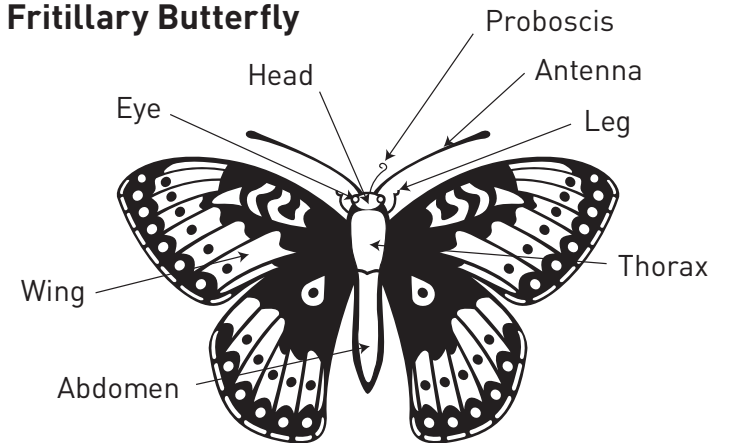

COOL SPRING FACT

An ant can carry 10-50 times its body weight. There are more than 10,000 species of ants around the world.

Scavenger Hunt

Check-off each item you find and then sketch or write what it is.

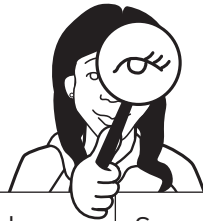

Something that needs air/oxygen to survive <input type="checkbox"/>	Something older than yourself <input type="checkbox"/>	Something smaller than your thumb <input type="checkbox"/>
Something that flies <input type="checkbox"/>	Something taller than you <input type="checkbox"/>	Something younger than yourself <input type="checkbox"/>
Something that you have not seen before <input type="checkbox"/>	Something with a scent <input type="checkbox"/>	Something with a bud <input type="checkbox"/>

Spring Phenology

The first time you discover each item below check it off and write down the date. Add your own things to watch for.

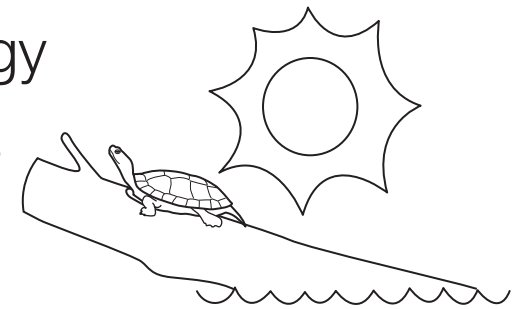

Date: _____

- Frogs begin to call _____
- Male red-winged blackbirds return _____
- First day wearing shorts outside _____
- Bird carrying nesting material _____
- Smell of mud in the air _____
- Worms on ground after spring rain _____
- Sap visible on tree bark _____
- Sighting of first baby animal _____
- First severe weather warning _____
- Turtles sunning _____
- First butterfly or moth sighting _____
- Sound of lawnmower _____
- Canada geese goslings appear _____
- First dandelion blooming _____
- Mushrooms popping up _____
- First mosquito bite _____
- Buds on trees start to open _____
- First 60 degree day _____
- Other _____ _____
- Other _____ _____

Water Cycle

Fill in the blanks with the word that best describes what is happening in the water cycle.

Precipitation

Transpiration

Evaporation

Infiltration

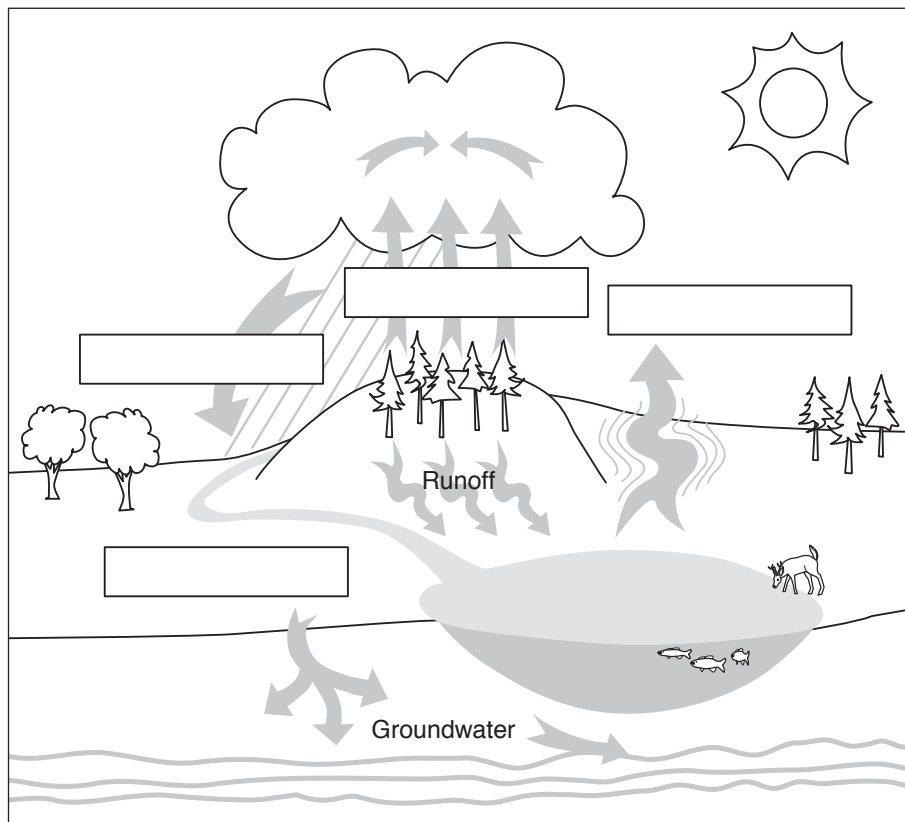

Inside a Tree

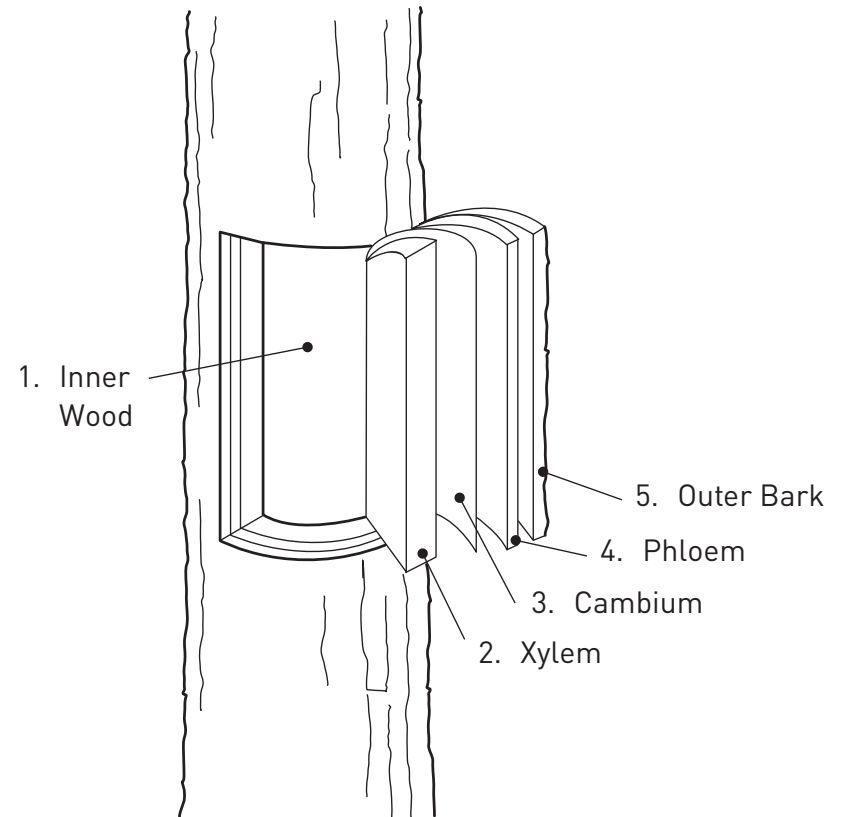

1. Inner Wood—supports tree, stores growing compounds and sugars
2. Xylem (zahy-luh m)—carries water and minerals from roots to leaves
3. Cambium (kam-bee-uh m)—makes trunk, branches and roots thicker
4. Phloem (floh-em)—carries food (sap) from leaves to rest of tree
5. Outer Bark—dead tissue that protects the tree from injury

Buds, Leaves and Branches

Draw the items below.

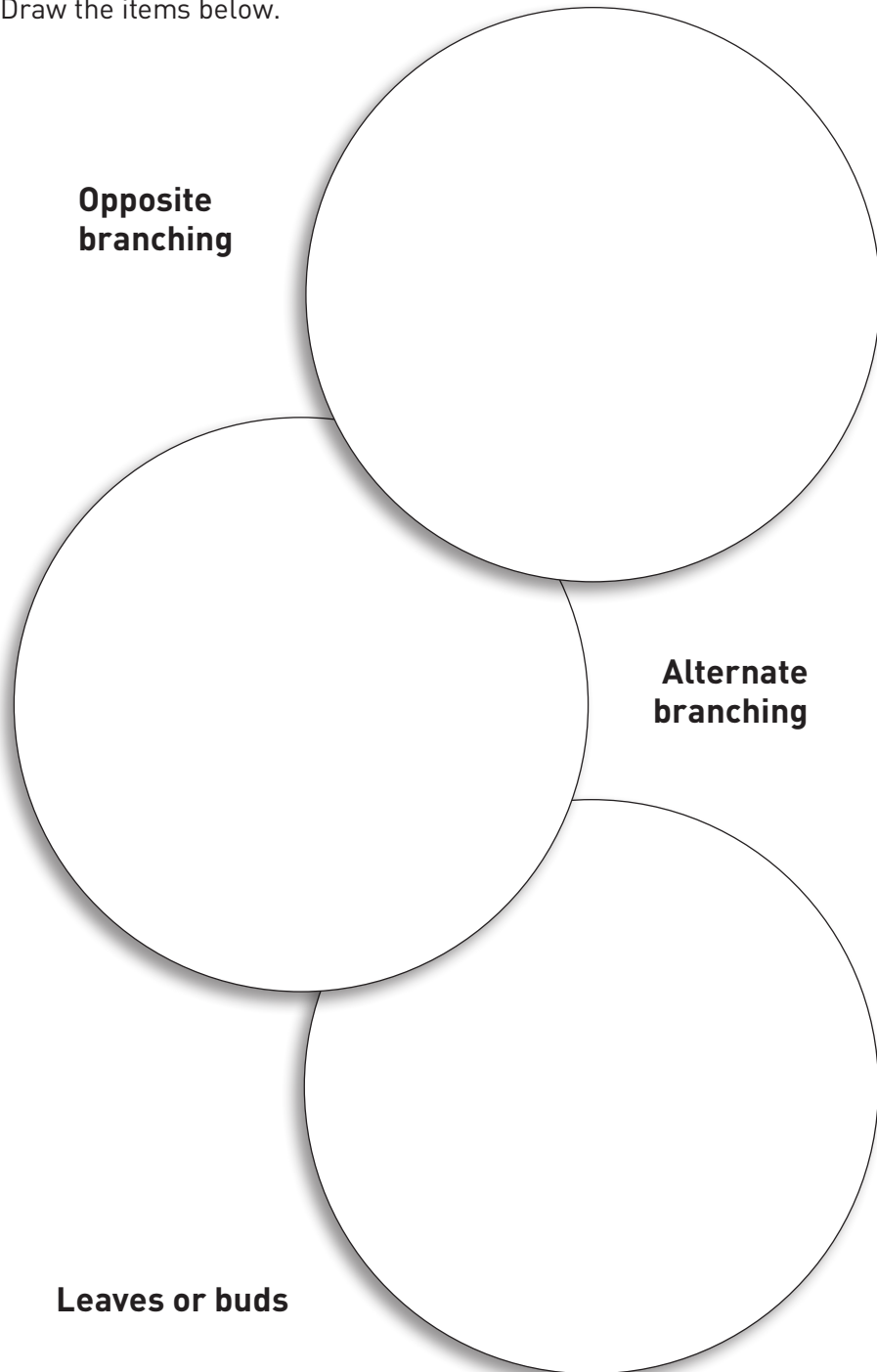

Common Cloud Types

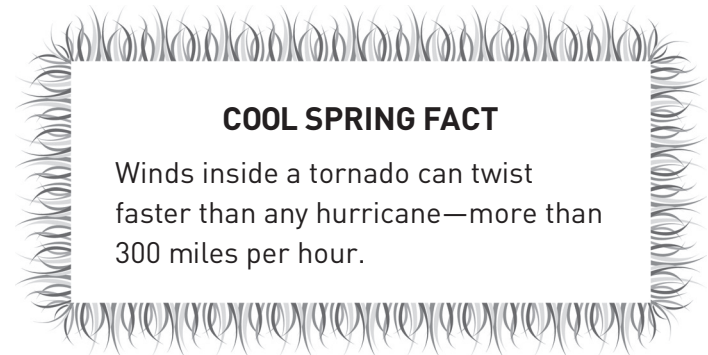
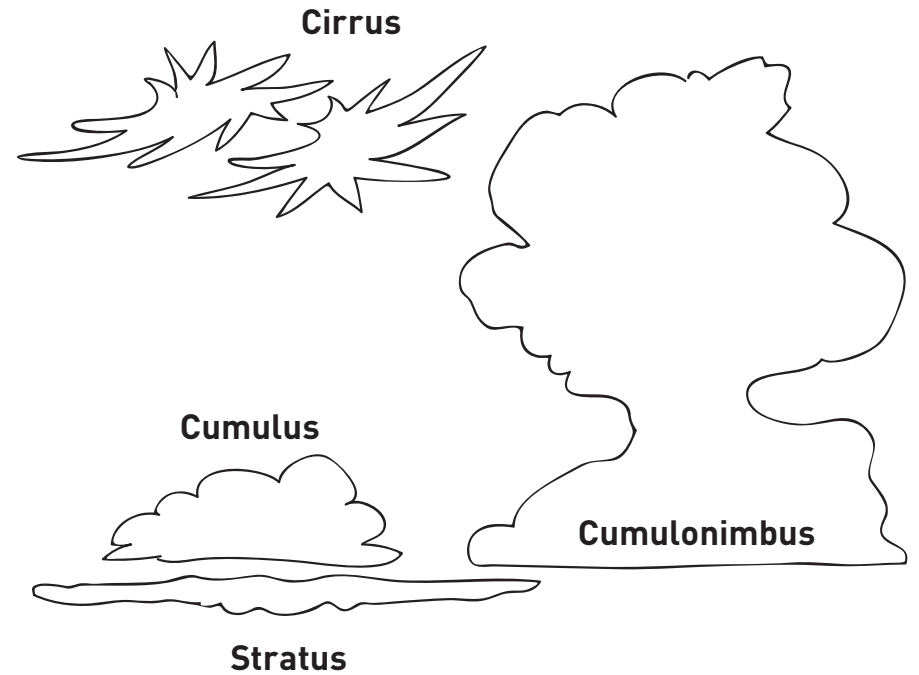

Temperature

32 degrees Fahrenheit is freezing

0 degrees Celsius is freezing

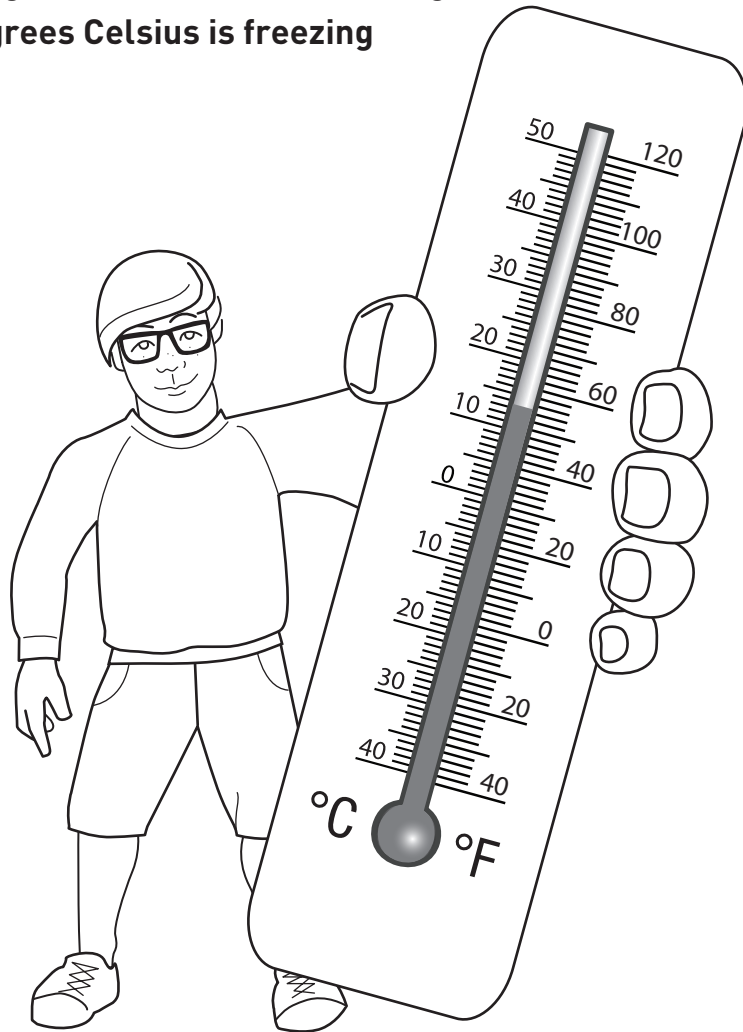

Conversion formulas

Fahrenheit to Celsius

$$^{\circ}\text{C} = (^{\circ}\text{F} - 32) \times \frac{5}{9}$$

or

$$^{\circ}\text{C} = (^{\circ}\text{F} - 32) \times .56$$

Celsius to Fahrenheit

















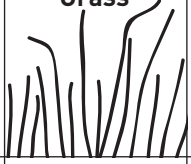

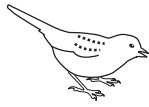

$$^{\circ}\text{F} = ^{\circ}\text{C} \times \frac{9}{5} + 32$$

or

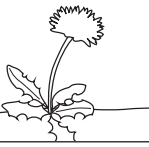
$$^{\circ}\text{F} = ^{\circ}\text{C} \times 1.8 + 32$$

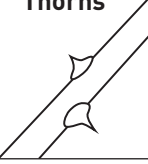
Spring Nature Bingo

Take a walk outside and try to find each one of the objects on the bingo board. Cross off the ones that you find. Yell "nature!" if you find five objects in a row or diagonally.

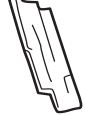
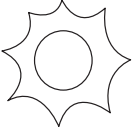
Ant 	Clouds 	Leaf bud 	Soil 	Birds nest 
Seeds 	Robin 	Grass 	Puddle 	Wind 
Sparrow 	Leaf 	Free Space 	Squirrel 	Singing bird 
Rocks 	Dandelion 	Coniferous tree 	Thorns 	Fly 
Other	Butterfly 	Flower 	Bark 	Sun 

COOL SPRING FACT

Hatched in the south, Green Darner dragonflies migrate north in the spring, traveling up to 87 miles per day.

Spring Word Scramble

Take the letters that appear in the shaded boxes and place them in order in the boxes at the bottom to reveal a spring message.

STHUNDRTORME 

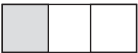
NAT 

REVAPOATION 

DDPUEL 

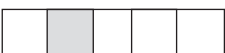
YLMEX 

SCUMLUU 

PRACEIPITIONT 

OEFLWR 

LOIS 

BROIN 

GILHTNNG 

 !

Severe Weather Safety

Severe Weather Awareness Week is April _____.

A **watch** means weather conditions are favorable for dangerous weather to occur such as a thunderstorm, tornado or a flash flood.

A **warning** means the weather event (thunderstorm, tornado or flash flood) is occurring somewhere in the defined warning area and that people need to take shelter as soon as possible.



Lightning safety tips

Lightning is dangerous. It kills about 100 Americans each year, more than tornadoes, and causes about 300 injuries. Every thunderstorm produces lightning! To be safe during a thunderstorm do the following:

- Get inside a building or enclosed vehicle.
- If you are caught in an open area with lightning around, crouch down immediately! Put your hands on your knees, but don't lie down on the ground.
- Do not use a landline phone or electrical appliance when lightning is taking place. A nearby lightning strike can travel through phone or power lines, right into the home.
- Never seek shelter beneath one lone tree.



Weather Tracker

Create a bar graph for temperature and wind speed. Enter a symbol for cloud conditions and precipitation.

Temperature (°F)

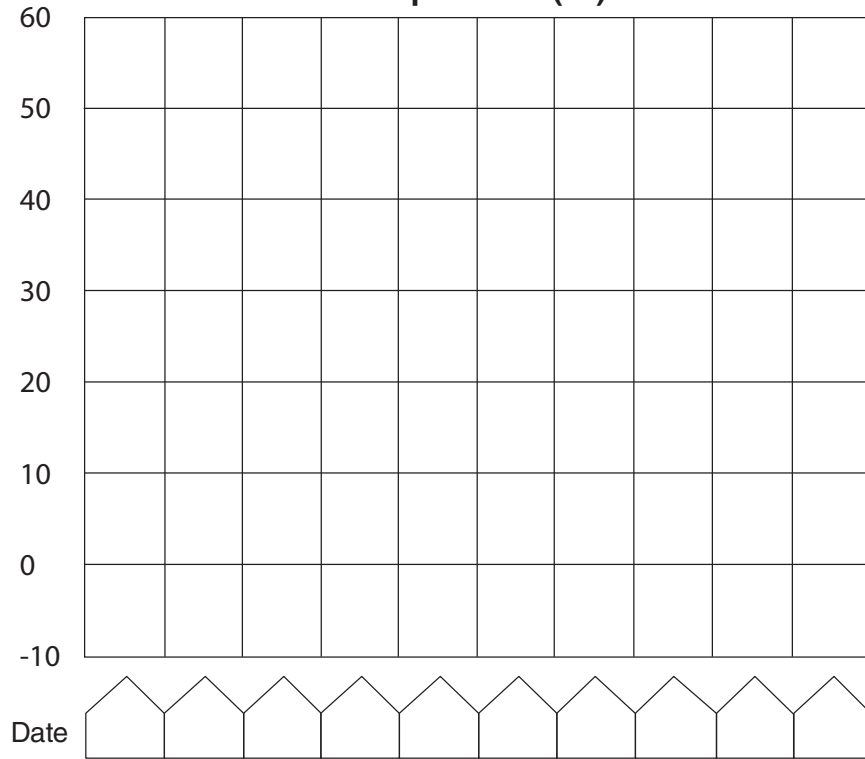

Wind Speed

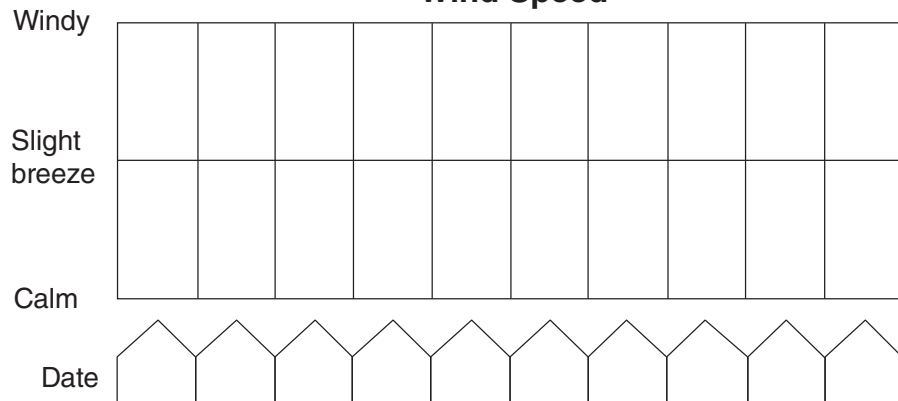

What Type of Soil Does Your Site Have?

Soil particle size comparison

Clay	Silt	Sand
(Larger than actual size)		

A soil profile

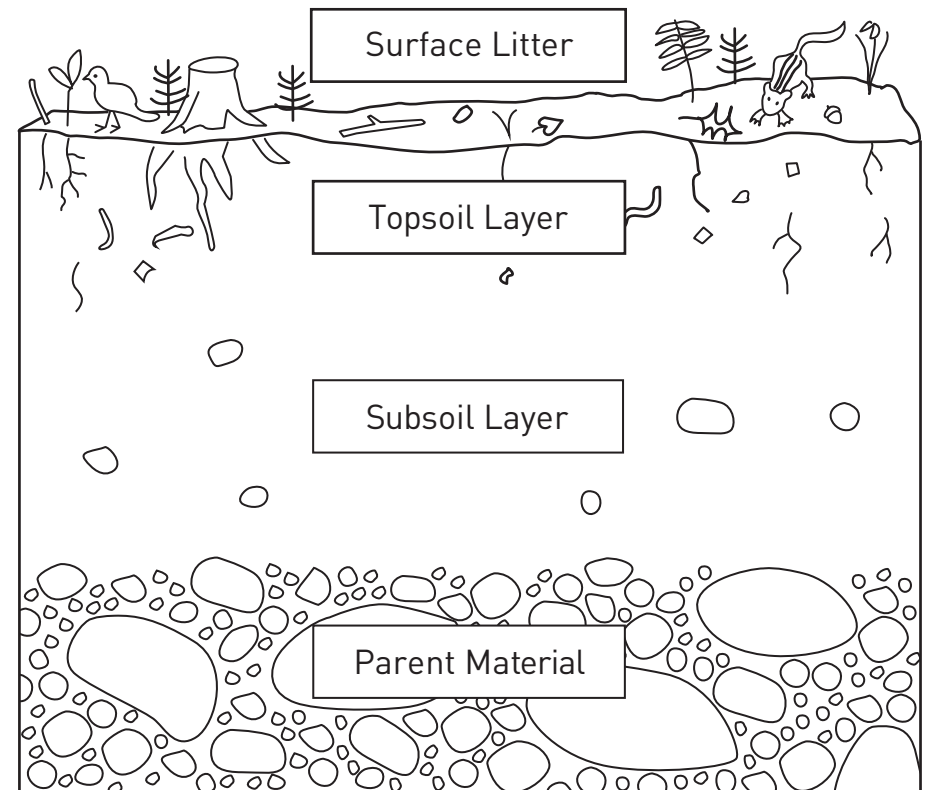

Dandelion Parts

Flower

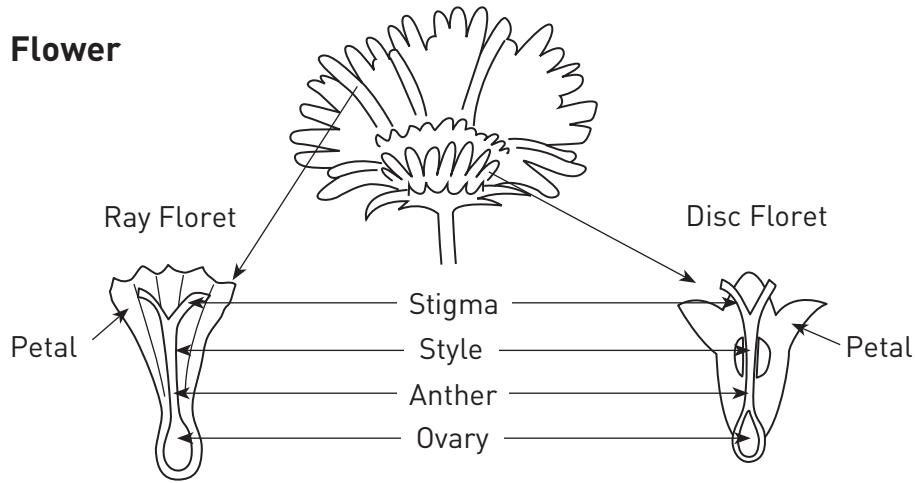

Life cycle

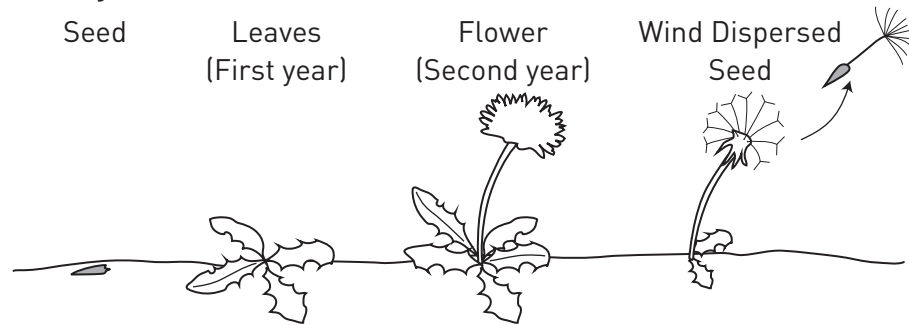

Going to seed

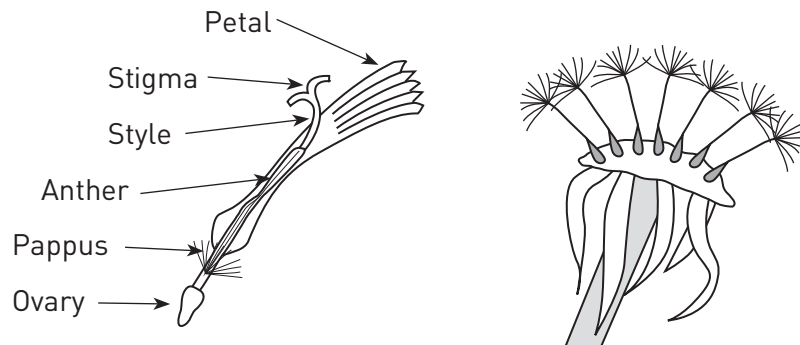

Cloud Conditions



Cirrus



Cumulus



Stratus



Cumulonimbus



None

Date	<input type="text"/>	<input type="text"/>	<input type="text"/>	<input type="text"/>
Date	<input type="text"/>	<input type="text"/>	<input type="text"/>	<input type="text"/>

Precipitation



Rain



Sleet



Snow



None

Date	<input type="text"/>	<input type="text"/>	<input type="text"/>	<input type="text"/>
Date	<input type="text"/>	<input type="text"/>	<input type="text"/>	<input type="text"/>

Bird Migration

Which bird species will travel the farthest back to Minnesota this spring? _____

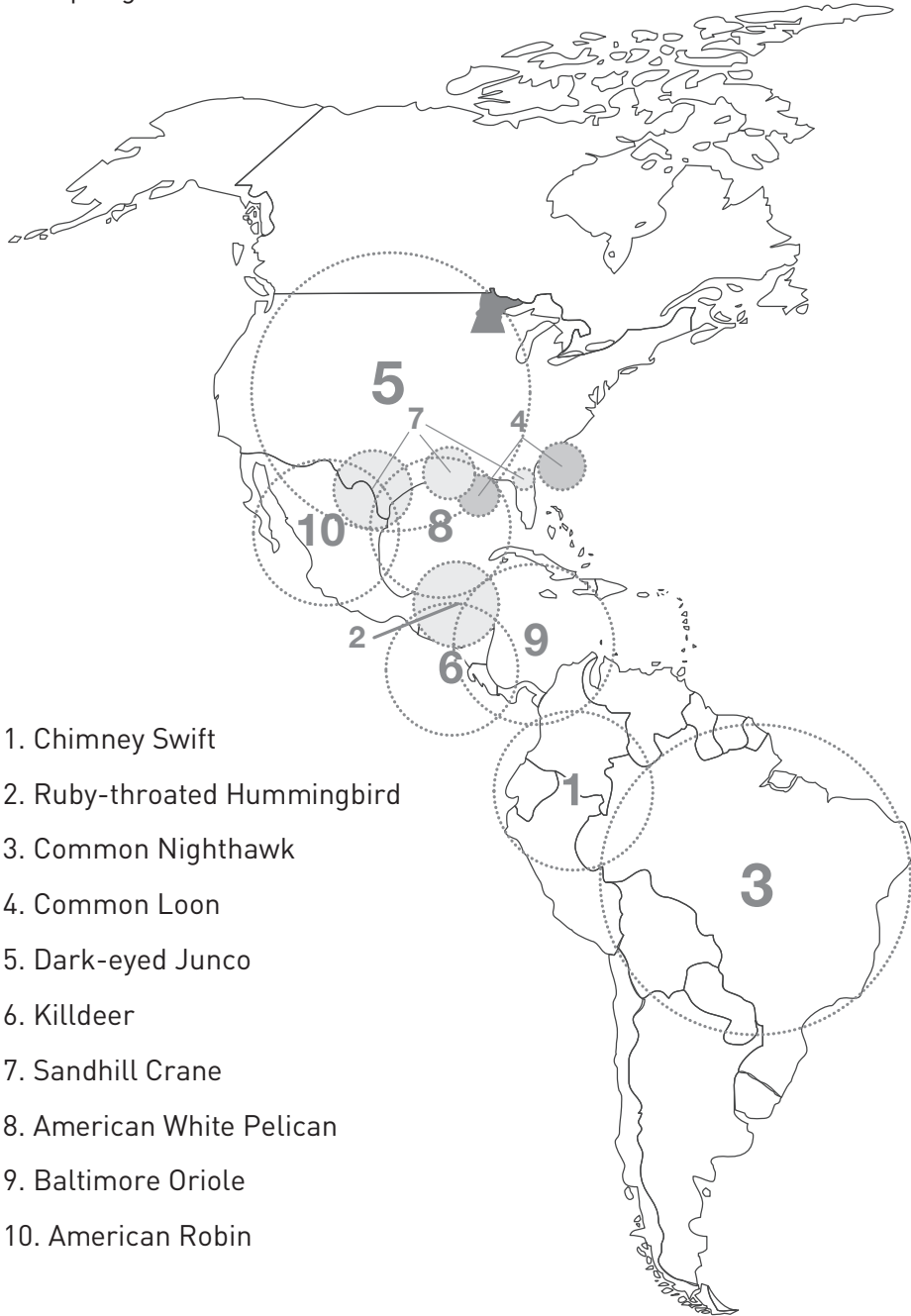



1. Chimney Swift
2. Ruby-throated Hummingbird
3. Common Nighthawk
4. Common Loon
5. Dark-eyed Junco
6. Killdeer
7. Sandhill Crane
8. American White Pelican
9. Baltimore Oriole
10. American Robin

Field Guide

Field guides help you to identify plants and animals found in nature. There are many kinds, big and small, but all contain some basic information such as: common name, scientific name, a picture and description.

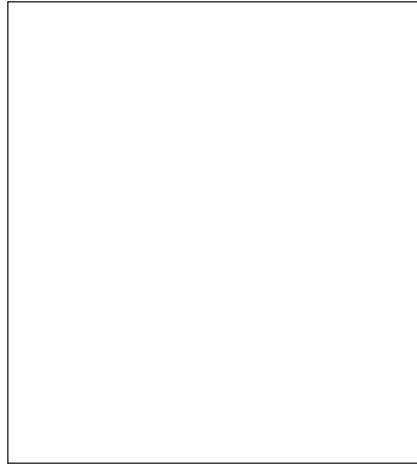
Create your own imaginary plant or animal field guide entry below.

Common Name	

Scientific Name	

Description	



UNIVERSITY OF MINNESOTA | EXTENSION



MINNESOTA MASTER NATURALIST

Minnesota Master Naturalist Explorers Spring Curriculum

A TIME FOR NEW ARRIVALS AND THE AWAKENING OF NATURE



IN PARTNERSHIP WITH:



Minnesota Master Naturalist Explorers Spring Curriculum

A TIME FOR NEW ARRIVALS AND THE AWAKENING OF NATURE

Authors:

Dawn Flinn, Education Coordinator, Minnesota Department of Natural Resources
Britt Forsberg, Explorers Coordinator, University of Minnesota Extension
Darren Lochner, Explorers Coordinator, University of Minnesota Extension

Curriculum Reviewers:

Sara Aker, Prior Lake Savage School District
Bev Blomgren, Minnesota Master Naturalist Volunteer
Pete Cleary, Naturalist, Dodge Nature Center

Partners/Sponsors:

Funding for this project was provided by the Minnesota Environment and Natural Resources Trust Fund as recommended by the Legislative-Citizen Commission on Minnesota Resources (LCCMR).

Portions of this material are reprinted with permission from Strauss, A.L., Homayoun, T., Meyer, R., Nippolt, P.L., Oberhauser, K., Peterson, C., Rager, A. & Young-Isebrand, E. (2015). Driven to Discover: Facilitator's Guide to Citizen Science. St. Paul, MN: University of Minnesota Extension. For more information about the Driven to Discover project, please visit www.extension.umn.edu/citizenscience.

Table of Contents

GETTING STARTED WITH EXPLORERS	4
ICEBREAKERS	5
Nature Makes Me Feel	5
Who Am I?	5
Animal Search	5
ACTIVITIES	
NATURE JOURNALING	6
Constructing a Nature Journal	8
Onion Hike	8
NATURE OBSERVATION BASICS	9
Find a Pencil	10
Closer Look	11
Paint Chips	11
SPRING WEATHER WATCH	12
Beaufort Scale	14
Find the Wind	14
Transpiring Leaves	14
Cloud Formation	14
Lightning Freeze Tag	15
INTRODUCTION TO A TREE	16
Know Your Branch	17
Connect the Branches	18
Meet a Tree	18
Tree Height	18
SOIL SURVEY	20
Searching for Worms	21
ALL ABOUT DANDELIONS	22
Fun with Dandelions	24
ANT SEARCH	25
Life in the Sidewalks	26
MIGRATION MANIACS	27
Bicycle Spokes	29
Slice of Silence	29

NATURE BINGO	30
Question Trail	30
EXPLORERS SCAVENGER HUNT	31
Nature Alphabet Search	31
Scavenger Hunt with a Twist	31
Nature Wristband	32

GETTING STARTED WITH EXPLORERS

The Minnesota Master Naturalist Explorers program, developed in 2011, worked with elementary students across the state of Minnesota to foster their curiosity about the world and provided an opportunity for Master Naturalist volunteers to share their knowledge and passion for the outdoors with youth. The Minnesota Master Naturalist program, a partnership between the University of Minnesota Extension and the Minnesota Department of Natural Resources, operated the Explorers program with generous support from the Legislative-Citizen Commission on Minnesota Resources (LCCMR) through the end of the grant period on June 30, 2015. The following materials were developed to assist Master Naturalist volunteers as they planned one hour sessions, once each week for four to eight weeks.

First Day Schedule

Arrive early and be prepared with supplies to set the room up. You should have familiarized yourself with the activities you will be conducting prior to this day.

Welcome individuals as they arrive. Attendance should be taken to assist with learning names. When all participants have arrived, introduce yourself. Share something interesting about yourself with the group. Introduce the Explorers Program and briefly mention that you are a volunteer with the Master Naturalist Program, a program sponsored by the Minnesota Department of Natural Resources and University of Minnesota Extension. It is helpful to share basic information about the structure of the program, “For the next six Mondays we will be learning about the outdoors and nature. Each week we will be spending some time outdoors so be sure you dress for the weather.”

Conduct an ice breaker activity to start the day.

Hand out Explorers backpacks, journals, tree cookie name tags, pencils and permanent markers. Have participants put their names on these items. Ask what it means to be an Explorer. Refer participants to page 1 of their journal for what Explorers do and what the rules for Explorers are.

Introduce the Minnesota Weatherguide Environment Calendar by showing the day’s date and the calendar features. Briefly mention that each week participants will be using the calendar to look at average temperature and phenological events. Phenology and the study of seasonal changes can be introduced on the first day.

It is recommended to take a brief hike around the schoolyard the first day. The hike can be used to make basic nature and weather observations.

Wrap up for the day. Ask the participants what they observed outdoors and summarize the topic of the day. Collect backpacks, journals, pencils and name tags. Take materials home with you in the materials bin.

Every Day

Consider bringing in a natural “object of the day” that relates to the topic you will be teaching about. This can be placed at the front of the room for the participants to look at as they come in to see if they can figure out what it is and what they will be exploring that day. Suggestions can be found at the beginning of each main activity.

Welcome participants, take attendance, hand out backpacks, journals, pencils and name tags.

Refer to the Minnesota Weatherguide Environment Calendar for weekly phenology, average temperatures and other relevant information.

ICEBREAKERS

The ice breaker activities are designed to be used at the beginning of each session or incorporated throughout the daily lessons. They can help participants feel comfortable with each other and the leader as well as help transition from the normal school day to the Explorers program.

Nature Makes Me Feel

Have everyone stand in a circle. Explain that each person should start by saying, "Nature and/or being outdoors makes me feel _____" and then respond with an expressive gesture. The leader gives an example, "Being outdoors make me feel HAPPY" and then he/she smiles or "Rain makes me want to jump in puddles" followed by jumping up and down. Adapt question based on the season and/or the current weather. When everyone has taken a turn, you can go around again with a different response.

Who Am I?

Place a name tag with an animal or plant found in Minnesota during the fall on the back of each individual. Participants are only permitted to ask one yes or no question per person about their animal or plant. They can go back through the group a second time and ask one question per person if the group is small or more time is needed. The goal is for the participant to guess the plant or animal on his or her back. This activity can also be done by giving only one participant the name of a Minnesota plant or animal and have the class ask questions to figure out the answer.

Animal Search

Prior to the participants' arrival, come up with a list of five native Minnesota animals. This number might vary depending on the size of the group. Spread the participants out around the classroom or outdoors. Whisper the name of one of the animals into each participant's ear. There should be at least two participants with the same animal name. When all players have been named, instruct them to find the rest of their "species" or fellow animals by making the sound or acting like the animal. The activity ends when all animals have found their fellow partners. Examples of animals might include owl, bear, wolf, wild turkey, frog or snake.

NATURE JOURNALING

Adapted from a *Keeping a Journal*, Monarch Lab, University of Minnesota.

Objective

To learn the basics of a nature journal.

Supplies

Explorers' nature journals

Pencils

Thermometer

Minnesota Weatherguide Environment Calendar

Objects of the Day: Examples of nature journals, plant and animal sketches and field guides

Magnifying glass (optional)

Camera (optional)

Background

Keeping records and taking measurements are important to being an Explorer. Good observations come from spending time looking at natural surroundings and making recordings through data collection and drawings. These recordings can be important for short and long term understanding of the environment.

The nature journal can be used to keep track of observed natural characteristics and changes in the environment made through written observations, recorded data and/or drawings. Observations might be based on the senses; sight, smell, touch or recorded data such temperature (actual vs. average), clouds types and wind. The journal is also a tool to record the seasonal phenology and changes around the schoolyard and surrounding neighborhood.

Emphasize that the participants do not need to be expert artists or writers to be good at journaling. Every journal entry is a good entry. Encourage participants to notice as many details as possible. Add labels to the drawings and note details like the date, location and weather. Provide examples of journal entries for the participants either from your own experience or in the Explorers' nature journal to help them get started.

Phenology is the science of seasonal changes and their effect on the natural world. A phenologist is someone who studies the changing of the seasons. Tracking events takes time and patience. First, you have to learn to be a good observer. Second, you have to become an accurate recorder of what you observe. Third, you have to become a critical thinker, finding links among the phenomena you are observing.

Activity

1. Explore and discuss the objects of the day.
2. Ask the participants why it is important to keep nature related records and measurements. What tools and supplies are needed? What would cause us to all have different observations?
3. Encourage participants to practice observation and description skills using words and drawings. Journal prompts are often helpful with weekly entries. Prompts might be sentences or key words that often help to initiate a journal entry. Refer to *Nature Observation* in the Explorers' nature

journal (page 3). The first time the journals are used, take a brief field trip around the schoolyard and record things the participants see. Share the list with each other.

4. One way to practice recording observations is to map the area of the schoolyard that will be visited during the Explorers program. Note key features like buildings, trees or paths. See Draw a Map of Your Site in the Explorers' journal for the mapping exercise (pages 4-5). The key can be used to draw symbols such as trees, shrubs or other landscape features to place on the map. The compass rose can be used to label the cardinal directions of North, South, East, and West. A good way to remember the letters and order on the compass rose is Never Eat Soggy Waffles. Consider sharing an aerial map of the schoolyard from a program such as Google Maps to show the participants another perspective of the area. Participants might also select a site in the schoolyard or a tree to observe once a week through the Explorers program. Drawings and photographs may be used to document the changes week by week. Assign a date to each of the recordings.
5. Record weekly weather observations such as temperature and general weather conditions such as precipitation and clouds on the Weather Tracker pages in journal (pages 10-11). Clouds may be classified by type or by the amount of coverage – clear, partly cloudy, mostly cloudy or overcast. Ask the participants how making weather observations is different when outside versus looking out the window or viewing photographs. Encourage the participants to compare the weather forecast printed in newspaper or on TV for a particular day with the actual weather conditions. Was the meteorologist accurate? Refer to the Minnesota Weatherguide Environment Calendar as a reference for average temperature data and weekly phenology.
6. Share the information presented in the phenology section of the Minnesota Weatherguide Environment Calendar. It is found after each month's calendar page. Define "phenology" and discuss seasonal changes to watch for in the upcoming month. Show participants the checklist of typical seasonal changes on the *Spring Phenology* page of the Explorers' nature journal and invite them to look for these changes as they go outside (page 7). Participants should observe and record any of the signs of fall in their journals and share with the group.
7. Other questions refer to the season. What are signs of spring? Refer to the Minnesota Weatherguide Environment Calendar and the Explorers' nature journal (page 7). Why it is important for naturalists and scientists to notice as many details as possible? Encourage participants to make general predictions of seasonal phenology. How do fall temperatures and hours of daylight/darkness change as the season changes and what effects do these changes have on plants, animals and weather in the area? What changes happen outdoors when spring arrives, temperatures decrease, etc.? Encourage the participants to observe changes as the seasons change from fall into winter and winter into spring on the *Phenology* page of the Explorers' nature journal (page 6).

Extensions

Constructing a Nature Journal

Objective: To construct a take-home nature journal.

Supplies: Colored cardstock paper, white paper, hole punch, straight stick, and a rubber band.

Activity: Construct nature journal by folding at least five sheets of white paper and place inside a folded cardstock cover. Punch two holes near the folded edge and wrap a rubber band around one end of the stick, guide the rubber band down through the hole then along the back of the journal and up through the second hole. Finally, wrap the rubber band around the other end of the stick. Illustrated directions can be found at www.makingbooks.com/elastic.shtml. The nature journal can be personalized with the participant's name and drawings. Journals can be constructed at any point during the Explorers Program. Encourage participants to make journal entries near their school, neighborhood or favorite outdoor location. Participants are also welcome to add photos to the journal along with a description of the object.

Onion Hike

Objective: To follow a trail using only your sense of smell.

Supplies: Scents that are easy to follow such as an onion. You may also use flavor extracts from the spice aisle at the grocery store.

Activity: Mark out a trail using only an onion or other smells such as mint, anise or vanilla. Rub the scent on trees through the woods. Have participants try to follow the scent. You may consider hiding a treasure at the end of the trail as an added incentive. Ask participants if it was difficult to find the scent. What other scents did they discover? What makes this activity hard or easy? How do animals use their senses of smell in the spring? Have participants mark the scent trail on their Explorers' nature journal map and journal about what they discovered.

NATURE OBSERVATION BASICS

Objective

To explore the schoolyard using multiple senses and record observations in the Explorers' journal.

Supplies

Explorers' nature journals

Pencils

Objects of the day: Ruler, magnifying glasses or binoculars

Linnaeus List or other field guides (optional)

Background

Making detailed observations of the environment is important to scientists, naturalists and everyday people. Using all the senses can result in a well-rounded understanding of the surroundings.

Every known living organism is classified and named by a set of rules and guidelines. Those rules are used by all scientists around the planet. The names scientists use are called scientific names, not common names.

Common names are the ones you might use when talking with your friends or family. You call your pet a dog or a cat which is the common name. Scientists call those animals by a set of several names like *Felis catus*. That's a domestic cat. Common names for organisms can be confusing because anyone can make them up, and they may apply to more than one species. For example, the mountain lion also has other common names such as panther, cougar, or puma. The scientific name for the mountain lion in North America is *Puma concolor*. *Puma concolor* refers to only one animal.

Scientific names follow a specific set of rules. Scientists use a two-name system called a binomial naming system. Scientists name animals and plants using the system that describes the genus and species of the organism. The first word is the genus and the second is the species. The first word is capitalized and the second is not. A binomial name means that it's made up of two words (binomial). Humans are scientifically named *Homo sapiens*. The name is always in Latin because when this naming process started, most people everywhere knew Latin. Scientific names help scientists to study organisms, especially when working with other scientists since they know which species is being discussed no matter where in the world they may be.

The descriptions used in field guides often refer to the characteristics such as color, size and shape in addition to feeding and nesting habits and the distribution or range of the plant or animal. The range map on the *Field Guide* page can be used to show where the organism is found in Minnesota (page 16).

Activity

1. Explore and discuss the objects of the day.
2. Discuss what tools (if any) are needed to make nature observations. How might the tools assist with making observations?
3. Ask the participants if they have made any recent nature observations.
4. Review the expectations/rules for going outside.

Tips to share with the participants:

- Wildlife is often easily scared by sudden movement and loud noises.
 - Participants should be within view and be able to hear the instructor at all times.
 - Stay on the trails and pathways, unless told otherwise.
 - Walk slowly.
 - Look up, down and all around. If something catches your interest, stop to sketch it or write about it.
5. Refer to *Nature Observation* in the Explorers' nature journal (page 3). Spread the participants throughout the schoolyard. Encourage them to complete the observation page by using their senses. Senses may be used at the same time or you may encourage participants to isolate one sense at a time. Gather the participants together and compare and contrast the lists.
 6. While focusing on their sense of hearing, participants should close their eyes and concentrate on the sounds around them. You may also use blindfolds if available. Have participants list the different sounds - natural and those caused by humans. Ask how sounds could be different during different times of the day. With a partner or the whole group, have students share what they noticed when they closed their eyes.
 7. Ask the participants what unusual items they recorded. What sense resulted in the longest list? What sense was the most challenging to use? Encourage the participants to make nature observations when they go home and report their findings at the next gathering.
 8. Refer to the *Field Guide* page in the Explorers' nature journal (page 16). Also show the participants examples of field guides such as the Linnaeus List. Discuss what features help to identify plants and animals and review what information is included in a typical field guide. The field guide page in the journal provides an opportunity for the participant to create an imaginary or real plant or animal. The field guide includes information such as common name, scientific name, description, picture and range map.

Extensions

Closer Look

Objective: To amaze participants with the details not readily observable in nature and to practice using scientific tools.

Supplies: Magnifying lenses or binoculars

Activity: Review how to use the tools and give each individual or pair of participants binoculars or a magnifying lens and allow them to explore. Consider narrowing the focus of a hand lens exploration by challenging participants to discover the smallest living thing or something they never knew existed. Test the binoculars use by asking participants to read words or count something far away. In what ways do these tools help you explore nature? In what ways do they hinder your exploration?

Paint Chips

Objective: To challenge observation skills and increase awareness of nature's many details.

Supplies: Paint sample strips

Activity: Distribute paint sample strips from a hardware or paint store to each participant. Instruct each participant to find a color in nature that exactly matches a color on the paint sample. Did you find an exact match? Is an exact match possible? Why or why not? Were you surprised by how easy or challenging it was to find a match?

Slice of Silence

Objective: To establish a sense of place by using all senses to explore.

Supplies: None

Activity: Have participants find a quiet place to sit alone in a natural area. Give them at least ten minutes to sit and savor the quiet. Discuss the experience: What did you see? Hear? Smell? Touch? How did your experience change as time passed? You may also use blindfolds if available to help participants focus on their senses of hearing. Have participants list the different sounds - natural and those caused by humans. Ask how sounds could be different during different times of the day. With a partner or the whole group, have students share what they noticed when they closed their eyes

SPRING WEATHER WATCH

Objective

To determine and record basic weather observations such as cloud cover, precipitation and temperature.

Supplies

Explorers' nature journals

Pencils

Minnesota Weatherguide Environment Calendar

Cloud photos/drawings

Thermometer

Objects of the day: Weather page cut from a newspaper or glass jar with frozen water to observe condensation as the ice melts

Background

Meteorologists are scientists who study the weather and the atmosphere. They are best known for forecasting the weather. In this activity, participants will make and record their own weather observations. They will also make connections between changes in the weather and seasonal changes in nature by using the Minnesota Weatherguide Environment Calendar.

High and low temperatures - by recording the daily high and low temperatures throughout the season and comparing them to the rest of the year, participants will see that fall and spring experience greater temperature differences than summer and winter months. By comparing the average temperature for the date and actual readings participants can make seasonal connections and know what kind of weather to expect.

The water cycle is the process through which water molecules move between the atmosphere and the Earth's surface. The main components are precipitation, condensation, evaporation, infiltration, and transpiration.

- Precipitation - moisture, often in the form of rain or snow, that falls to the ground
- Evaporation - when water molecules turn to vapor form and rise into the atmosphere
- Condensation - the opposite of evaporation, when water vapor in the air converts into liquid form
- Transpiration - when plants give off water vapor through tiny pores in their leaves
- Infiltration - the process of water soaking into the soil from the ground level

A cloud is made up of many tiny droplets of condensed water or ice crystals. Clouds help return water to the earth through condensation and precipitation.. Note that the warmer summer months usually result in more variety in cloud types.

A few common cloud types include:

- Cirrus - High wispy, thin clouds spread out high in the sky, horsetails

- Stratus – Clouds in low flat layers, spread out over most or all of the sky, fog
- Cumulus – Big puffy clouds, like giant cotton balls, reduce transpiration and evaporation
- Cumulonimbus – Clouds that can grow very large and tall, often bring rain and storms

The back of the Minnesota Weatherguide Environment calendar and the Explorers' nature journal provide photos of different cloud types. In addition, check out the following websites:

<http://cloudappreciationsociety.org/collecting/> has a helpful diagram of cloud types.

Web Weather for Kids – Clouds: <http://eo.ucar.edu/webweather/cloud3.html>

Activity

1. Explore and discuss the objects of the day.
2. Ask participants what they might typically observe in nature during this time of year. Refer to the *Spring Phenology* checklist in the Explorers' nature journal (page 7). Explain that weather can affect how animals behave.
3. Highlight daily weather information along with phenology information for the week found in the Minnesota Weatherguide Environment Calendar. Refer back to this information when outside with the group.
4. With the help of participants, draw, label and discuss the main parts of a water cycle including: precipitation, condensation, evaporation, infiltration and transpiration. You can do this on a white board or large sheet of paper as well as with the Explorers' nature journal (page 8).
5. Discuss the water cycle's connection to weather, the movement of water and ways water moves through the cycle in the spring.
6. Have participants look at the different cloud types in their journals (page 9). In addition, show photos in the Minnesota Weatherguide Environment Calendar or copies of cloud photos from websites. Discuss how clouds are formed. Ask where clouds fit in the water cycle. Which type of cloud brings us rain? Thunderstorms?
7. Go outside and have participants lie on their backs to observe the clouds. They can sketch their shapes in their journals. Ask participants how many different cloud types they observed. Are there differences in the clouds depending on the direction you look? Can you predict what the weather might be tonight? What types of clouds do you see? What else do you notice in the sky?
8. Use the Explorers' nature journal *Temperature* page to explain how to read a thermometer (page 10). Have one person from the group determine the actual temperature by looking at the thermometer you brought along. Have participants record the temperature in their journals. As an instructor, you can keep a graph of daily temperatures and average daily temperatures found in the Minnesota Weatherguide Environment Calendar. Together, look at trends across the weeks of the Explorers program. Discuss how changes in temperature can affect organisms.
9. While outside also record wind speed, cloud conditions and precipitation for the day on the *Weather Tracker* pages in the Explorers' nature journal (pages 12-13). Compare and contrast conditions from week to week. Also, notice if there is a difference in the number of birds you see or other animal behaviors depending on the various weather conditions.
10. Highlight that Severe Weather Awareness Week is in April. Cumulonimbus clouds are often the sign of a strong storm brewing, refer to picture in journals. In case of severe weather it is

important to know what to do. Look at the *Severe Weather Safety* in the Explorers' nature journal for severe weather terms and what to do in case of bad weather (page 11). Fill in the dates of Severe Weather Awareness Week; this changes annually but can be found at <http://weatherawareness.dps.mn.gov>.

11. Gather items and head inside. Ask participants to watch the evening weather forecast during the week or review the forecast online then check to see if the meteorologist's forecast was correct the following day. When you return the following week, discuss what participants noticed about the forecast during the week.

Extensions

Beaufort Scale

Objective: To understand how to describe wind speed.

Supplies: Copy of Beaufort scale from www.weatherwizkids.com/weather-wind.htm

Activity: Determine wind speed using the Beaufort scale which is an empirical measure for the intensity of the weather based mainly on wind power. The wind speed is determined by making basic environmental observations.

Find the Wind

Objective: To determine which the direction the wind is traveling.

Supplies: Container of bubbles

Activity: Since we cannot see the wind participants, investigate the direction and speed of the wind using bubbles. Ask if participants can feel the breeze. How can you tell if it is a windy day? Have them look for different signs of the wind blowing (the movement of plants, branches on trees, exhaust in the air, etc.). Make a list of ways to "see" the wind. Now blow bubbles and try to determine which way the wind is blowing. Do the bubbles change direction? When? Why? Are the bubbles moving in the same direction as the clouds? Winds often blow in different directions. Warm air can blow in one direction and cold air in another. Check out www.weatherwizkids.com/weather-wind.htm to learn more about wind.

Transpiring Leaves

Supplies: Plastic bags, twist ties

Activity: Have participants tightly tie a plastic bag over one to three different types of leaves outside. Come back later and notice the condensation on the bag showing that transpiration is taking place. Are the different leaves transpiring equally? Why or why not?

Cloud Formation

Objective: To understand how a cloud forms.

Supplies: Clear two-liter plastic bottle, warm water, matches

Activity: Demonstrate how a cloud is formed by three main ingredients. Fill a clear plastic two-liter bottle one-third full of warm water then cap. Water vapor (1st ingredient) fills the inside of the bottle from the evaporating warm water. Take the cap off, light a match and hold it near the bottle opening. Gently blow out match, drop it into the bottle and quickly cover with cap. Smoke, dust and other particles (2nd ingredient) help make clouds. Squeeze bottle hard and release. What happens? A cloud appears when you release and disappears when you squeeze. The 3rd ingredient needed is a drop in air pressure.

Lightning Freeze Tag

Objective: To understand how to protect oneself from lightning.

Supplies: None

Activity: This variation of freeze tag will model ways to be safe from lightning. Designate the game zone. Have one to two people represent lightning; they are considered "it." The lightning can chase other participants and tag them. If a participant is tagged, her or she is out. People can protect themselves from the lightning by crouching down and putting their hands on their knees, but they are only allowed to hold this pose for five seconds. If a participant is lying on the ground, hiding next to a tree/object or running around the lightning can tag them. Continue until one person is left and that person replaces one of the lightnings.

INTRODUCTION TO A TREE

Objective

To understand how to observe and record the different types of trees growing in the schoolyard and compare their characteristics.

Supplies

Explorers' nature journals

Pencils

Magnifying glasses

Rulers

Branches with both opposite and alternate arrangements as well as buds

Tree cookie name tags, large tree cookie or photo of tree cookie

Objects of the Day: Deciduous and coniferous tree branches with buds and/or leaves

Tree field guides (optional)

Background

Trees can be found on most schoolyards and are a great way to watch the season progress as daylight gets longer. The main part of this activity will occur on the first visit but throughout the weeks make sure to take a little time every session to have participants observe their trees, looking for any changes and noting them in their journals.

There are two main types of trees. In general, deciduous trees lose all of their leaves in one season and coniferous trees keep their sharp and narrow leaves called needles on the tree year-round. Coniferous trees produce cones that carry their seeds. In fall, deciduous trees begin to shed their leaves to conserve energy and limit damage to the tree from the snow and storms during the winter.

Many people think you can't tell trees apart once the leaves have fallen off. However, by closely examining the buds and bark, you are often able to identify trees.

The main parts of the inside of a tree include:

- inner wood - supports the tree, stores growing compounds and sugars
- xylem - carries water and minerals from roots to leaves
- cambium - makes trunk, branches and roots thicker
- phloem - carries food (sap) from leaves to rest of tree
- outer bark - dead tissue that protects the tree from injury (much like human skin).

More information can be found at

<http://www.mndnr.gov/forestry/education/treeforallseasons/index.html>

Activity

1. Explore and discuss the objects of the day.

2. Ask participants how they might identify trees in the spring. Make a list of tree features that may be helpful in identification: height, diameter, bark texture, leaves, shape, etc.
3. Point to a tree or show a spring tree photo and ask participants to make some general observations. How might those features change in the summer, fall, and winter seasons? How many different kinds of trees do participants think they will find on the school grounds? Have them write their predictions in their Explorers' nature journals.
4. Show and discuss the differences between a deciduous and coniferous tree.
5. Open to *Buds, Leaves and Branches* in the Explorers' nature journal (page 20). Using real branches, show the difference between an opposite and alternate branch and have participants make a quick sketch of each in the appropriate circle. Then show at least two different kinds of spring buds and have participants sketch one in the bottom circle.
6. Have each participant predict the number of kinds of trees in the schoolyard and write it in their journals. Go outside and give participants five to ten minutes to find and count as many different species (not numbers) of trees as they can within the boundaries you set. When time is up call them back in and have them write their answers in the Explorers' nature journals. How close were they to their predictions?
7. Group participants in pairs and have them select a tree to adopt in the schoolyard. Have participants tie a small piece of yarn on a low branch to identify their trees. Pass out rulers and magnifying glasses for participants to make detailed observations.
8. Ask participants to record and sketch their trees on *Nature Observations/Field Sketches* in their Explorers' nature journals (pages 25 or 26). They should include: leaves or buds (color, shape, size, and other observations), bark (color, shape, size, and other observations), tree height and shape and any other observations. Make sure participants write down the date of their observations. If they have made a map in their journal of the schoolyard add the location of their tree to this map (pages 4-5).
9. If time, include other observations like what the tree smells and feels like. What signs are there that animals have used the tree? Do a bark rubbing. Determine the circumference (C) around the tree. Using a flexible tape measure, measure to the nearest inch the distance around a tree at a point 4½ feet up from the ground (C). Then convert this number into the tree's diameter (D) using one of these formulas $D = C \times .3183$ or $D = C/3.1416$.
10. Take a few minutes every week to have participants revisit their tree and record the date and any changes they see.
11. Gather participants together and return to the classroom. Using their tree cookie name tags, refer to the *Inside a Tree* page and review the different parts, how to pronounce them and what they do (page 21). Could they see any of these parts on their tree? Why or why not? Do they think the phloem is active now? Why or why not? What about the xylem?
12. Ask participants to notice the different trees that they see on their way home or when traveling to other places.

Extensions

Know Your Branch

Objective: To recognize characteristics of tree branches by touch.

Supplies: One branch for each participant, blindfolds (optional)

Activity: Place a stack of branches on a table or the floor. Ask each participant to be blindfolded or close his or her eyes and find a branch. Once each participant has a branch, ask participants to get to know their branches by feeling and recognizing characteristics like length, branching pattern or texture. Place the branches back in the middle, have the participants take the blindfolds off and then find the branch they were holding. The branches can be a mix of deciduous and evergreen species, shapes and sizes.

Connect the Branches

Objective: To closely observe tree branches and pay attention to all characteristics.

Supplies: Pairs of branches

Activity: Before the Explorers session, cut branches of several different tree species in half. Assign each branch to a participant and ask him or her to find its matches in the classroom by using clues like color and texture of bark, branching, buds, shape or size.

Meet a Tree

Objective: To identify trees using senses other than sight.

Supplies: Blindfolds

Activity: In groups of two or three, participants blindfold one member of their group and carefully lead the person to a tree. The blindfolded person gets to know the tree by feeling, smelling, listening to it, feeling for the tree's neighbors, etc. When the blindfolded person is confident that he or she knows the tree, the rest of the group leads the blindfolded person back to the starting point. After removing the blindfold, the newly sighted person attempts to relocate his or her tree. Rotate jobs until everyone has had a turn. Were participants able to find their trees? How did participants identify their trees? How are some trees different from other trees?

Tree Height

Adapted from *Teachers' Guide to Arbor Month*, Minnesota Department of Natural Resources.

Objective: To estimate the height of a tree using ratios.

Supplies: Twelve inch ruler, masking tape, measuring tape

Activity: Height is the hardest tree measurement to obtain. Use a ruler and follow the instructions below to estimate the height of trees in the schoolyard.

1. On a 12-inch ruler, mark the 1-inch and 10-inch lines with tape.
2. Group participants in pairs.
3. Person A stands at the base of the tree.
4. Person B, while holding the ruler up in front of their eyes at arm length, moves back until they can see the whole tree from top to bottom between the 0-inch and the 10-inch mark on the ruler.

5. Person B then moves the ruler until the base of the tree is exactly at 0-inches and the top of the tree is sighted exactly at 10-inches.
6. Person B sights out from the ruler's 1-inch mark to a point on the trunk above the base.
7. Person A marks this spot on the trunk with tape.
8. Measure the distance from the base of the tree to the 1-inch mark (X) on the tree.
9. Multiply by 10 to get an approximate height of the tree.

SOIL SURVEY

Objective

To learn about the different types of soil.

Supplies

Soil samples

Different-sized athletic balls for demonstration

Clear jar with cover

Water

Hand wipes or paper towels

Magnifying glass

White paper

Shovel or hand trowel

Object of the day: Soil samples

Flour and sugar (optional)

Background

Soil is the main reason why certain plants grow in some places and not in others. Other environmental factors such as temperature, moisture/precipitation and sunlight play a role as well. Soil is the foundation for life on planet Earth. It is composed of mineral particles (non-living), organic matter (plant and animal material that was once living), water and air. Different soils are categorized based on their parent material (where the soil originated) and the size of the mineral particles. Refer to the soil profile (page 17) in the Explorers' nature journal.

Soil scientists describe soil types by the amount of sand, silt or clay that is present. Sand is often made up of larger particles with a lot of space for air. Sand cannot hold water well and tends to lose nutrients quickly. Silt soil has medium sized particles and is often made up of organic matter like dead leaves along with some sand and clay. Silt soil is often smooth and slippery to the touch when wet. Clay has small particles and often sticks together in clumps; this leaves little room for air and water. Clay is often sticky when wet. Loam soil is a combination of all three soil types and is ideal for plant growth.

Activity

1. Explore and discuss the objects of the day.
2. If available, use athletic balls to represent soil by the size of the particles and how water drains through. You may also wish to draw the different size particles on a white board or in the Explorers' nature journal (page 17).

Sand - Use a basketball to show that large particles do not fit well together and leave large spaces between. Water drains quickly through sand and particles do not stick together.

Silt - Use a baseball to show how medium particles fit together with less space between them. Soil with a high percentage of silt retains some water. It can form a ball but will break apart.

Clay - Use a golf ball or marble to represent small particles with small spaces between. Wet clay forms a ball or a clump and does not break up easily.

3. Ask participants to bring in small samples (about a cup) of soil from their homes. In addition, the instructor should bring in samples to share. Each sample should have documentation as to where it was collected and what was growing at the location.
4. Place a small amount of the soil sample on a white sheet of paper. Examine each sample using a magnifying glass. Ask some of the following questions: What does the soil look like? What does it feel like? What does it smell like? What color is the soil? Why might soils be different colors?
5. In order to learn more about a specific sample of soil, empty the sample into a clear jar with a lid. Fill the jar half full with soil and the rest with water. Shake for several minutes until the large clumps are broken apart. Let the jar settle for the rest of the class period and examine how the different soil particles have settled. The leader might also perform this same experiment the day before to demonstrate how the soil settles over time. The top layer will be clay which includes the lightest and smallest particles. The middle layer will be silt and the bottom will be sand, or the largest particles. The sand also settles first and at the bottom because it is heavier. Compare different soil samples side by side upon completion of this experiment. The soil samples can be taken from various locations around the schoolyard.
5. Head outside and look around the schoolyard for areas of exposed soil. Feel the soil and determine if it is sand silt or clay. What plants are growing nearby?
6. As a wrap-up, ask participants: What happens to plants when soil drains quickly or slowly? What are some examples of plants found in areas with sand or clay? Does soil stay in the same location or does it move around? Discuss erosion and the historical movement of soils due to glaciers.
7. If you do not have athletic balls or access to different soil types, you may use common baking items to demonstrate the different types of soil particles. Compare textures with sugar (sand), flour (silt/loam) and flour/water mixture (clay). Pass out samples of the three types of soil to each small group. Determine what type of soil each is. How do the soils compare to the sugar, flour and dough?

Extension

Searching for Worms

Objective: To find earth worms in the schoolyard.

Supplies: Mustard powder (from the spice aisle at the grocery store), one gallon milk jug with tap water, clean water to rinse worms.

Activity: Most people think of earthworms as friendly creatures that can be helpful to gardeners. However, what many people do not know is that earthworms are not native to Minnesota and can have a negative effect on forests because they change the pace at which nutrients are cycled in soil. You can easily find worms in your backyard or a forest by using a mixture of mustard powder and water. Mix $\frac{1}{4}$ cup mustard powder with 1 gallon of water, shake well and slowly pour onto a small area of soil. The mustard mixture irritates worms' skin but it does not harm them. The worms will crawl to the surface where participants can pick them up, rinse them and observe. How many different kinds of worms can participants find? Using magnifying glasses, what do you see? How do worms move?

ALL ABOUT DANDELIONS

Adapted from *Dandelions*, Vermont Institute of Natural Science (VINS) www.VINSweb.org.

Objective

To learn the basic parts of a dandelion flower.

Supplies

Explorers' nature journals

Pencils

Magnifying glasses

Clear tape

Object of the day: sunflower, sunflower seeds

Small shovel (optional)

Plastic table knife (optional)

Other flowers (optional)

Background

Dandelions grow in many different places and were brought to the United States by people from Europe who used the plant for medicine and food. Most people consider the dandelion a weed since it grows easily in lawns. A weed is often described as a plant out of place or a plant that grows where we do not want it. They have the potential to out compete other desired plants such as turf grass.

The word "dandelion" comes from the French "dents de lion," or teeth of a lion, which describes the deeply toothed leaves. During the first year of life, these leaves are the only part of the dandelion plant above ground. The leaves produce food from the sun which is then stored in the long carrot-shaped tap root. It does not start producing flowers until the second year.

The main parts of the dandelion include the tap root, leaves, stem and flower. Broken pieces of root may grow into new plants and leaves from dandelions that have not been sprayed with pesticides or herbicides can be eaten.

What looks like the yellow head of the dandelion flower is really composed of a cluster of many tiny flowers. Dandelions belong to the plant family Asteraceae, also called the Daisy family. This family contains plants that have many flowers grouped together on a flower head, like the sunflower. One dandelion flower head contains about 300 small dandelion flowers called florets.

Parts of the dandelion flower include:

- Anther - the part of a stamen that produces and contains pollen and is usually borne on a stalk
- Petal - one of the modified often brightly colored leaves of the flower
- Stigma - usually the top part of the pistil of a flower which receives the pollen grains and on which they germinate
- Ovary - bottom portion of the pistil that bears the ovules

- Pappus - an appendage or tuft of appendages that crowns the ovary and functions in dispersal of the seed
- Bracts - modified leaves that cover the flower when it is closed, otherwise found at the base of the flower head
- Floret - the complete flower that contains yellow petals, white hairs (pappus), the female part (pistil of) (ovary, style, stigma), male part (anthers)
- Pollen - powdery and yellow in dandelions, this is the male part that fertilizes the female part
- Stamen - small stem like features with anthers at the end

Most flowers have male (pollen) and female (ovule) parts. The pollen of one plant fertilizes the ovule of another like plant. Maybe you have seen a bee or other insect with pollen on its body moving from flower to flower. Insects help pollinate many flowers including dandelions. However, dandelions are interesting because they can also reproduce without being fertilized. This is called apomixis. In fact, most dandelions produce seeds by apomixis, where unfertilized ovules in the ovaries produce seeds that will become clones of the parent plant. That is why dandelions look so much like each other in an area, because they are! Dandelions can also grow a new plant from a piece of their tap root left in the ground.

Activity

1. Explore and discuss the objects of the day.
2. Tell participants they will be going on a lion hunt today. The lions they will be looking for live outside this building, have a shaggy yellow mane and sharp teeth. What kind of lions are we looking for? Dandelions. Note: This activity works best on sunny days when the dandelion flowers are open. On rainy or cloudy days you can open up the closed flower heads in a plastic bag indoors.
3. Work as individuals, pairs or small groups to find and collect dandelion flowers in these life stages: leaves only, with a closed flower head, with an open flower head, and as a plant with a seed head.
4. Go outside and collect the above items, then gather together in a large group and review the life stages and some of the larger parts of the plant: root, leaves, stem, and flower head. Make sure you have permission if you are going to dig up a dandelion to show the long tap root. Compare these parts and life stages of the plant to the pictures on the *Dandelion Parts* page in the Explorers' nature journal (page 16). Did you find all of the above parts? Why or why not?
5. If it is not windy, take the dandelion heads to a hard surface such as a sidewalk or playground. If not, return inside to an area where you will be able to dissect your dandelion heads. Using the picture on the *Dandelion Parts* page in the Explorers' journal and magnifying glasses, look for the different parts of the flower head: disc floret, ray floret, anther, petals, stigma, ovary and pappus (page 16). Have participants tape at least two of these parts into their journals. Is the flower releasing pollen? Why or why not? How can you tell?
7. Look inside an ovary for the ovules. These are super tiny! When fertilized they will become seeds. Explain the three ways dandelions reproduce (piece of a root, pollination, apomixis). What might pollinate the dandelion? What do the ovules look like?

8. Count how many florets (little flowers also called disc flowers) are in one head and write the number in the Explorers' journals. Florets in the center that are not open yet should still be counted. Who has the most?
9. Try to estimate how many seeds will be produced. Count the number of seeds on a dandelion seed head then count the number of blossoms or seed heads on a plants in the lawn. Multiply the two numbers and you'll have the number of seeds the plant produces. It is a lot! How can dandelions spread so easily?
10. Clean up your area and recycle your flower pieces outside.

Extension

Fun with Dandelions

Objective: To look at dandelions in a new light.

Supplies: Dandelion flowers and leaves, spoons, salad dressing (optional)

Activity: Try these variations to exploring dandelions – A. Some people believe if you rub a dandelion flower under your chin and your chin turns yellow it means you like butter. B. Take a stem, push one end into the hole of another and make a bracelet. You could also hook many circles together and make a dandelion chain. C. Blow the seeds into the air and have a partner see how many they can catch. D. With a safe, clean leaf, dip it into some salad dressing and have a taste. E. Make rubbings of dandelion leaves by placing the leaves under a sheet of paper and rubbing the paper with the back of a spoon.

ANT SEARCH

Objective

To develop an awareness of ants and their connection to the environment around them.

Supplies

Explorers' nature journals

Pencils

Object of the day: Plastic or preserved insect specimen

Magnifying glasses (optional)

Background

Insects are the most numerous type of creature on the planet. Insects play an important role on earth. Ants are social insects and live together in big groups called colonies. Ants communicate by tapping their antennae to pass signals. Good communication is important for ants because they need to work together to survive. Highly successful, ants range from the Arctic to the tropics in large numbers. There are several hundred species of ants living in North America and over 10,000 worldwide. Each colony of ants has a hierarchy (ordered system) usually composed of a single queen that lays eggs, attendant females that care for the queen, female worker ants that care for young and provide food, and female soldier ants that protect the colony. The male ant population is usually small and they often die after mating.

Ants have three body parts; head, thorax and abdomen. Their six legs are attached to their thorax (see Explorers' nature journal page 23). Ants work together in teams to ensure the colony survives. Ants use their antennae to touch, taste and smell. While on the search for food, ants leave a trail with pheromones (odors). If you were to put all in the ants in the world together they would weigh as much as all the people in the world; they have the same total biomass. Ants are the strongest creatures in relation to their size and can carry objects 10-50 times their body weight.

Activity

1. Explore and discuss the object of the day.
2. Prior to the activity, search the schoolyard for ant colonies along sidewalks and other paved areas. Place some food (cracker, cat food, honey, soda, etc.) near active ants.
3. With participants, provide some basic rules for observing and interacting with the ants. These may include using caution when observing because some ants might bite, be careful around ant hills because these are the ants' homes and treat ants with respect when interacting with them.
4. Show participants to the ant trails you found earlier. Ask some of the following questions: Where are the ants coming from and going to? Why might they be moving in these directions? Estimate the number of ants observed in the colony. Describe the behavior of the ants. What are they doing? Are all the ants the same size?
5. Ask the participants to journal about what it would be like to be an ant. What would the view be like? Participants could try lying on the ground and looking across the grass/landscape. What would be some of the challenges with moving around in nature? What would the ant's home look like?

Extension

Life in the Sidewalk

Adapted from *Schoolyard, Ecology and Exploration*, University of Minnesota.

Objective: To find ants in unexpected places.

Supplies: Toothpicks or small sticks, Explorers' nature journal, rope or hula hoops, magnifying glasses, white paper (optional)

Activity: Find an area that has a cracked sidewalk or asphalt. Carefully examine what is in the crack. A toothpick or small stick can be used to extract some of the items from the crack. Look for any natural and human-made items (plants, seeds, soil, trash, insects, etc.) and make a list of these items in the Explorers' nature journal. The items extracted from the crack may be placed a white sheet of paper and examined with the use of a magnifying glass. Encourage the participants to compare their list. Locate an area covered with grass. Use a three meter section of rope to make out a circle area on the grass (hula hoops also work for this activity). As with the sidewalk crack make a list of any nature and human-made items.

What was the most interesting thing that you found in the sidewalk crack? In the grass? Compare the number of nature and human-made items from the sidewalk and grass areas. Which area had more of each item? How was the sidewalk crack environment similar and different from the grass area?

MIGRATION MANIACS

Objective

To define migration and identify obstacles that may be encountered during migration.

Supplies

Bird field guide

Explorers' nature journal

Pencil

20 foot piece of blue yarn or rope

Container of colored toothpicks

Paper plates (one per participant)

Object of the day: Pictures of birds that migrate

Linnaeus List (optional)

Binoculars (optional)

Background

Migration is the movement of animals from one place to another. Many animals migrate including some bats, the monarch butterfly and a variety of birds. Migration takes place mainly because animals are looking for food and warm climates for better survival. It is the change of seasons that causes this behavior to occur.

Minnesota is home to over 130 migratory bird species. Some birds travel a short distance while others migrate thousands of miles. Migratory bird species use different senses and cues to navigate and orient during migration such as looking for landmarks or sensing the changes in the earth's magnetic field (geomagnetism). Many birds embark on a 20-hour-plus nonstop flight over as much as 660 miles of the Gulf of Mexico. Neotropical migrants are those that migrate to Central or South America. They live in forests, wetlands and prairies including those in Minnesota during the summer and then migrate to forests, wetlands, grasslands and beaches during the winter months.

Birds may encounter many obstacles along the way including collision with windows, wind turbines or power lines, predators such as cats, habitat loss and lack of shelter, exposure to pesticides or bad weather, or lack of food or water.

Long migrations require birds to accumulate fat on their bodies to fuel their flight before they leave. Depending on the species they may eat a variety of seeds, grains, fruit, nectar and insects. Spring migrants return to Minnesota in order to raise their young. Human actions can have a positive or negative impact on these migrating birds. We can help bird migrants by putting up bird feeders, houses and watering stations, keeping cats indoors and hanging items over windows to deter collisions.

Activity

1. Explore and discuss the objects of the day.

2. Introduce the word migration and what it means. Migration is the movement of animals from one place to another. Can you think of any animals that migrate? Today we will be focusing on migrating birds. There are about 130 bird species that migrate in and out of Minnesota.
3. Show pictures of the ruby-throated hummingbird, common loon and American robin using the field guide or other sources. Have participants vote to choose one of these three bird species to investigate.
4. Look at the *Bird Migration* in the Explorers' nature journal (page 14). These are birds that live and breed in Minnesota during the summer, and then migrate south during the winter. Most of the birds listed here will be returning to Minnesota this spring. The dark-eyed junco is the exception as it actually travels further north in the summer. Some birds, like the robin, may be found here all winter if there is open water and berries to eat. Where does our chosen species migrate to? How does that compare to other birds on the page? Which birds are neotropical migrants? Many bird species spend the entire winter here; name a few. Migration is like going on a long trip. Discuss what you need when you go on a long trip. What do you think the class species needs to migrate? Is it the same thing we need when going on a long trip?
5. Head outside to with supplies to complete the bird migration obstacle challenge.
6. Set up the bird migration obstacles around the schoolyard with the group. At each area explain how these obstacles affect the birds and that participants will need to get through all of the obstacles in order to survive.
 - a. Place some blue yarn in the shape of a large oval on the ground. Explain that this represents the Gulf of Mexico or other large body of water some birds have to pass over. Participants will need to jump over the "water" without touching it.
 - b. Scatter red, green, yellow and natural colored toothpicks around a grassy area. Explain that the toothpicks represent food the birds will need to find and collect as they pass by (they will need at least one red and one green toothpick to survive but do not tell them this).
 - c. Next, they must climb over some playground equipment without touching the ground in order to avoid ground predators such as cats.
 - d. Then they run a lap around a designated area while flapping their wings quickly, if they stop running or flapping they die.
 - e. Last, they must land on some shelter, represented by paper plates. Have one fewer shelter than participants in the group, only one person is allowed on each shelter in order to survive and spend the night safely. Note: change the order of the course to fit the site.
7. Return to the beginning of obstacle course. Ask participants which bird species of the three discussed earlier they will represent; robin, hummingbird or loon. Often birds migrate in a flock (group) so try to keep up with each other. Say "Migrate!", and then watch as the "birds" migrate north. You may call them out if they do not complete an obstacle correctly, then they are dead. Have the "dead" birds assist you in watching the other migrants until the course is complete.
8. How many birds survived? What was the hardest obstacle? Explain that there are many other obstacles migrating birds encounter along the way. Can you think of others? By the time they arrive in Minnesota birds are often very tired and hungry. What are ways we can help them when they return?

9. If there is time and participants are interested, run the course one more time. Did more or fewer birds survive? Why?
10. As a group walk around the schoolyard and look and listen for birds. Can you find any new birds that have returned? How can you tell? If you don't know what a bird species, see if you can find it in the bird field guide. Look for newly migrated birds or flocks of distant birds weekly, listen for new bird calls too, record these in your journal.

Extensions

Bicycle Spokes

Objective: To challenge the senses of sight and hearing and change participants' perspectives on making observations.

Supplies: None

Activity: Have participants sit in a circle, then scoot directly back and lie down on their backs forming the shape of a wheel with spokes. Be silent for two minutes (or whatever amount of time seems appropriate). Describe what you heard. How many different sounds did you hear? What proportion of the sounds were non-human? How many bird calls did you hear? Were you surprised or impressed by anything you heard? What did you see from this perspective? Did you see any birds? In what ways would you act differently if this was your perspective all the time? Try this activity at the base of a tree with everyone's feet on the tree's trunk. How is the tree different from the perspective of the roots?

Slice of Silence

Objective: To establish a sense of place by using all senses to explore.

Supplies: None

Activity: Have participants find a quiet place to sit alone in a natural area. Give them at least ten minutes to sit and savor the quiet. Discuss the experience: What did you see? Hear? Smell? Touch? How did your experience change as time passed? You may also use blindfolds if available to help participants focus on their senses of hearing. Have participants list the different sounds - natural and those caused by humans. Ask how sounds could be different during different times of the day. With a partner or the whole group, have students share what they noticed when they closed their eyes

NATURE BINGO

Objective

To explore the schoolyard using a nature bingo card.

Supplies

Explorers' nature journals

Pencil

Field identification guide (optional)

Background

Nature bingo encourages participants to summarize what they observed over the past several weeks. Nature bingo is a good way to wrap up the seasonal Explorers Program.

Activity

1. A bingo card is included with the Explorers' nature journal (page 19). As an alternative, each square of a blank bingo card can be filled in with items that the participants have observed throughout the program. Include a variety of plants, animals and other natural features of the schoolyard. The images of the items can be copied from clipart or the text/name can be included and the participant can sketch each item found.
2. Before going outside review each of the items included on the bingo card.
3. The goal is to get bingo (five squares in a row) or blackout (all spaces crossed off) on the card.
4. Review nature bingo items that were found and not found in the schoolyard.
5. Ask the participants to suggest items for future bingo cards that were not listed. Small prizes/treats could be provided for those who get bingo.

Extension

Question Trail

Adapted from *Exploring The Outdoors With Aldo Leopold*, Pheasants Forever.

Objective: To improve observation skills and practice formulating testable questions.

Supplies: Blank tags with string, pencils

Activity: Give each participant a tag and a pencil, and inform them of the boundaries of activity. Allow them to wander along the trail and come up with a question about something they see. Do not allow simple questions like, "What is this called?" but instead encourage more investigative questions such as, "Why is this bark different on the branch than on the trunk?" "How did this cob of corn end up in the woods?" "How did this squirrel die and what will happen to it?" When participants come up with questions, they should write the question on the tag and hang it from the questioned object or nearby.

Then, gather all participants at the head of the trail and walk down the trail addressing one question at a time. At each tag, facilitate a discussion on how to make the question listed into something they could test or investigate.

EXPLORERS SCAVENGER HUNT

Objective

To explore the schoolyard to find a variety of natural and human-made items.

Supplies

Explorers' nature journals

Pencils

Activity

1. Refer to *Scavenger Hunt* in the Explorers' nature journal (page 22), for items to find around the schoolyard.
2. Review and discuss each item before going outside.
3. Record in writing or with a sketch the items found around the schoolyard and surrounding area.
4. When done searching, ask the following questions: What are some additional items not included on the scavenger hunt form? What things are alike? Which ones are different?
5. Refer to the spring activity *Nature Observation Basics* for more ideas on making observations.

Note: Other items to include on the scavenger hunt might be something: green, with needles, twisted, curly, round, sticky; a seed, tree bark on the ground, feather, pinecone, something flat, something smooth, rough, red, a flower, leaf, dead twig, weed, or ant. Also, ask participants to compare two different areas such as a sidewalk/paved area to grassy/natural area. List the things that are similar and different between these sites.

Extensions

Nature Alphabet Search

Objective: To search nature items and find each letter of the alphabet.

Supplies: Digital camera (optional), Explorers' nature journals, pencils

Activity: This activity can be completed as a group or individually. Groups and individuals can be assigned groups of letters (i.e. A-F, G-L, M-R, S-Z) to search for. The 26 letters of alphabet can be printed on a sheet of paper to assist with the activity. Provide examples of what different letters might look like in nature before going outside. For example, a branched twig might look like the letters V or Y. The nature letter can be captured with photos or the participants can sketch the items in their journal. Ask, which letters were easy to find? Are there common patterns and shapes found in nature?

Scavenger Hunt with a Twist

Objective: To foster reflection on scientific objectivity.

Supplies: Value-laden words on index cards

Activity: Give participants cards with a value-laden word such as gross, unnecessary, special or valuable and instruct them to find something in nature that their word describes. Have them show

their findings to the group and explain how the object is described by their words. Were there participants who couldn't find something for their word? Does everyone agree with everyone else's choices? To what extent do our values predict and/or dictate our actions? What impact do our values have on how we view nature? How can you, as a scientist, remove human values from your descriptions of nature? Should you?

Nature Wristband

Objective: To create a wristband of natural items collected from the schoolyard.

Supplies: Tape (masking tape, duct tape or packing tape), natural items like small rocks, seeds, small leaves, pine needles, flowers, sticks, etc.

Activity: Measure around the participant's wrist and cut a piece of tape slightly larger than the wrist to fit over the hand. The tape needs to be sticky side out. Identify an area outside to collect natural items to stick to the wristbands. Do not stick live insects to the wristband. Try to find items on the ground versus picking them off plants. Ask the following questions: What did you find? Where did the items come from? Compare the wristbands and look for similarities and differences in natural items found. Encourage the participants to make a nature wristband at home and compare it with the one they just made.

Note: Natural items can be collected prior to class and this activity can be completed indoors.

REFERENCES

Jeffers Foundation. (2010). *Ecotime: Integrating Environmental Education*. Prior Lake, MN: Jeffers Foundation.

Leopold Education Project. (2009). *Exploring the Outdoors with Aldo Leopold*. Pheasants Forever.

Minnesota DNR Division of Forestry. (2002). *Teacher's Guide to Arbor Month: Activities on Trees and the Natural World for Grades K-8*. St. Paul, MN: Minnesota DNR.

Monarch Lab, University of Minnesota. *Keeping a Journal*. Retrieved on January 20, 2015 from http://monarchlab.org/images/uploads/curricula/Keeping_a_Journal_LC36.pdf.

Strauss, A.L., Homayoun, T., Meyer, R., Nippolt, P.L., Oberhauser, K., Peterson, C., Rager, A. & Young-Isebrand, E. (2015). *Driven to Discover: Facilitator's Guide to Citizen Science*. St. Paul, MN: University of Minnesota Extension.

Vermont Institute of Natural Science. (1986). *Hands-On Nature: Information and Activities for Exploring the Environment with Children*. Woodstock, Vermont: Vermont Institute of Natural Science.

Young-Isebrand, E. & Oberhauser, K. *Schoolyard Ecology Explorations: an Inquiry-Based Curriculum*. St. Paul, MN: University of Minnesota.

8 inch

7 inch

6 inch

5 inch

4 inch

3 inch

2 inch

1 inch

0 inch

COOL WINTER FACT

Largest snowman was actually a snowwoman made in Bethel, Maine in 2008. It was 112 feet high and had skis for eyelashes.



MINNESOTA MASTER NATURALIST

UNIVERSITY OF MINNESOTA
EXTENSION



MASTER NATURALIST EXPLORERS

Winter Nature Journal



Name _____

Date _____

The Minnesota Master Naturalist Explorers Program connects adult volunteers with youth in an after-school setting. The goal of the Explorers Program is to offer fun, outdoor, science-based educational opportunities for elementary students to learn about the ecology and natural history of their schoolyard, neighborhood, nearby natural areas, and the entire state.

Explorers is a component of the Minnesota Master Naturalist Program whose mission is to promote awareness, understanding, and stewardship of Minnesota's natural environment by developing a corps of well-informed citizens dedicated to conservation education and service within their communities.

Acknowledgments

Authors: Dawn A. Flinn, Minnesota Department of Natural Resources; Darren Lochner and Robert B. Blair, University of Minnesota Extension

Reviewers: Bev Blomgren, Pete Cleary, Sara Aker

Designer: Amy Beyer, Minnesota Department of Natural Resources

Funding for this project was provided by a grant from the Minnesota Environment and Natural Resources Trust Fund.



© 2015, Regents of the University of Minnesota. All rights reserved. Send copyright permission inquiries to: Copyright Coordinator, University of Minnesota Extension, 405 Coffey Hall, 1420 Eckles Avenue, St. Paul, MN 55108-6068. Email to extcopy@umn.edu or fax to (612) 625-3967.

University of Minnesota Extension and Minnesota Department of Natural Resources provides equal access to and opportunity in its programs, facilities, and employment without regard to race, color, creed, religion, national origin, gender, age, marital status, disability, public assistance status, veteran status, sexual orientation, gender identity, or gender expression. This material is available in alternative formats upon request.

Answers

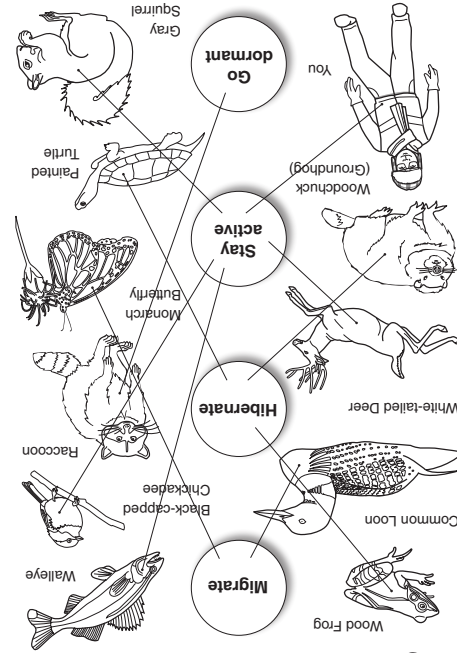

Winter Survival Answers
page 20

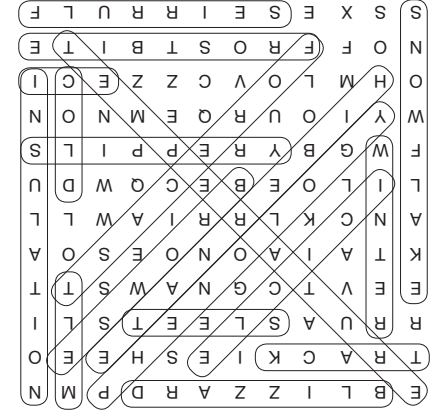

Nature Word Search
Answers page 19

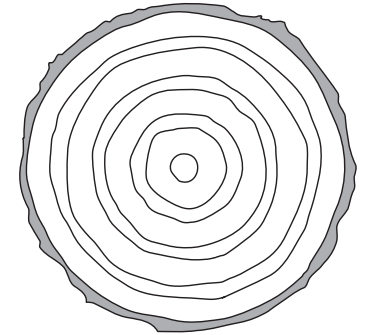

Tree Cookie Answers
page 13
How many years old is this tree?
8

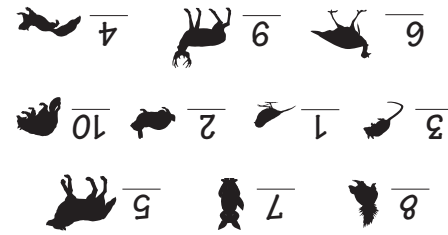

Match the Tracks Answers
page 16
8
7
5

Vocabulary Words

phenology—the science of seasonal changes and their effect on the natural world

journal—notebook or binder used to make recordings, drawings, and write thoughts and reflections

hibernate—when the animals' body processes slow way down and their temperature falls and they go to "sleep" and are hard to wake up

dormant—when the animal's body processes slow way down but its temperature does not fall and it may wake up often

migrate—regular movement of animals over relatively long distances

track—a footprint made by an animal

scat—the excrement (poop) of an animal

browse—to eat, nibble at, or feed on (leaves, tender shoots, or other soft vegetation)

sleet—rain that is made of some ice

flurries—a brief and light snowfall

frostbite—injury to body tissues (often exposed skin) caused by exposure to very cold temperatures

blizzard—a severe snowstorm with high winds and low visibility

COOL WINTER FACT

The first use of term "blizzard" (from boxing, meaning *volley of punches*) by the Esterville, Iowa *Vindicator* newspaper. March 14–16, 1870 a blizzard struck northern Iowa and southwest Minnesota with up to 16 inches of snowfall.

Introduction

Who is a Master Naturalist Explorer?

It is someone like YOU! A kid who is interested in nature, wants to learn more about it, and have fun exploring the outdoors.



Please do the following:

Be safe.

Be respectful of each other and nature.

Have fun!

What is a nature journal?

A nature journal is a booklet that helps you capture your experiences in nature. It is a place to write, sketch and record your personal observations and thoughts about nature. It is a great way to keep track of your discoveries over time.



Minnesota Biomes

In general, a biome is a large area of land with the same type of plant communities.

Put a star on the map to mark the location of your Explorers program.

What biome are you in? _____

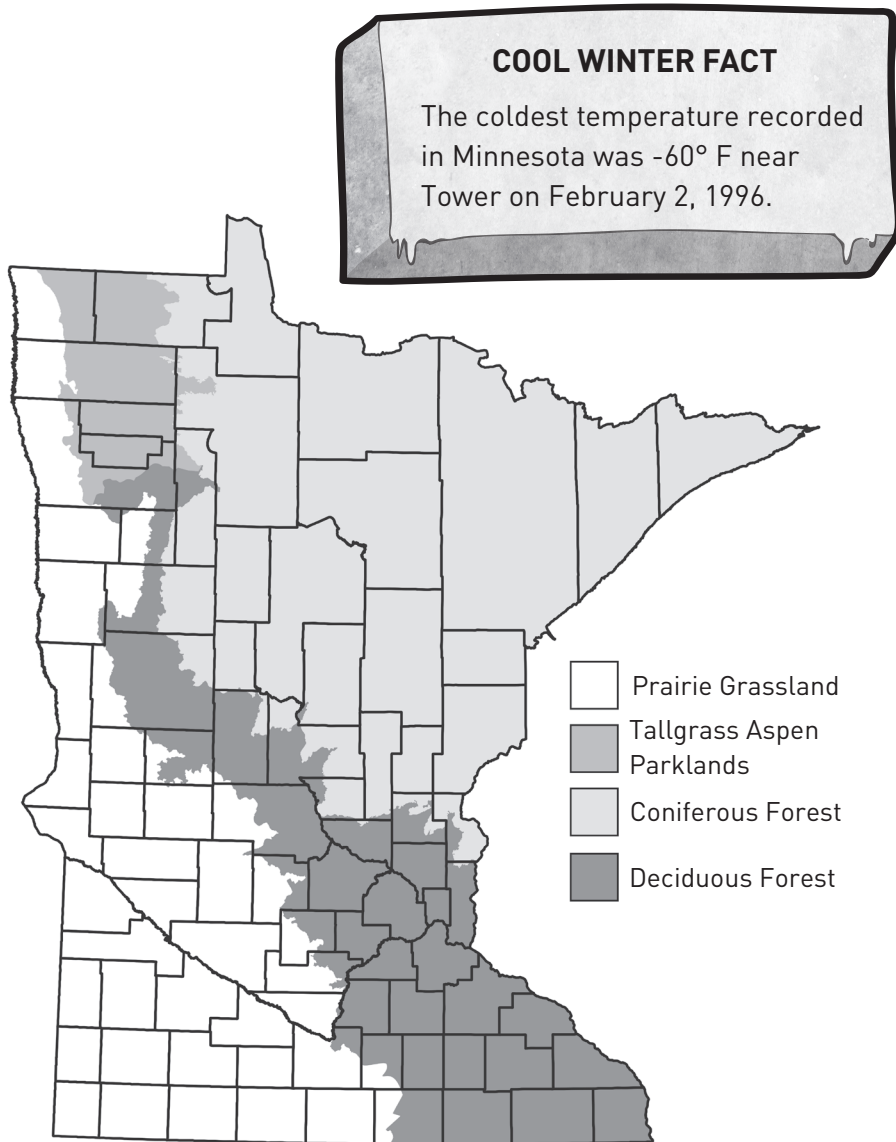

I Promise I Will Help Nature by:







Signature _____

Date _____

Nature Observations/Field Sketches

Nature Observation

Explore your site. Write or draw your nature observations in the boxes below.

 I see	 I feel
 I smell	 I hear

COOL WINTER FACT

Wood frogs in winter have ice inside their bodies between their organs.

Draw a Map of Your Site

Create a birds-eye view map of your Explorers program site. Draw in large items such as buildings, playgrounds, streets, grassy areas, trails, forests or snow piles. Create a key to identify major features.

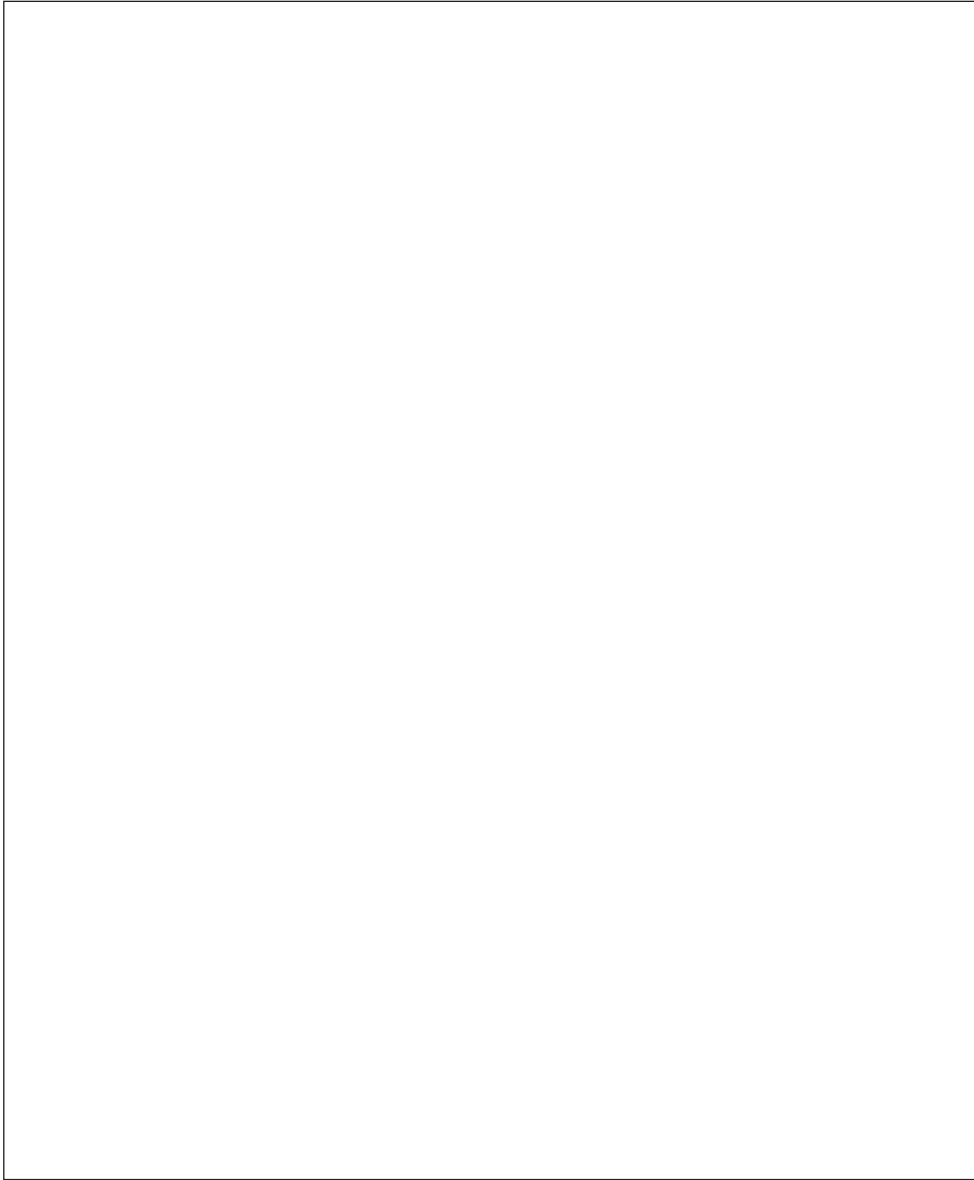

Nature Observations/Field Sketches

Nature Observations/Field Sketches

Key



Phenology

Phenology is the science of seasonal changes and their effect on the natural world. In the squares draw and/or write natural things that may be happening in the different seasons.

Spring	Summer
Fall	Winter

COOL WINTER FACT
A snowflake has six sides.

How to Draw

Take one step at a time to draw a snowflake. No two snowflakes are alike.

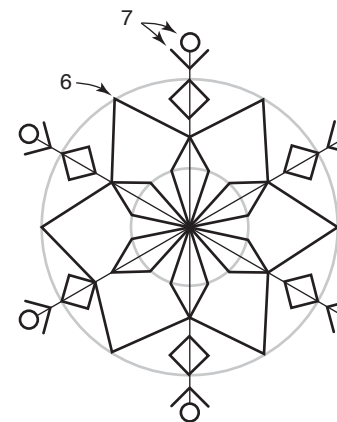
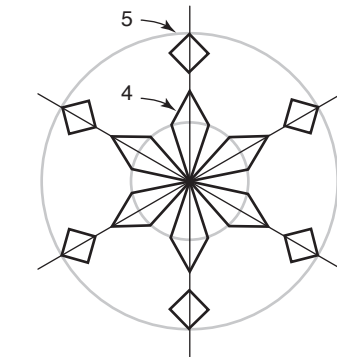
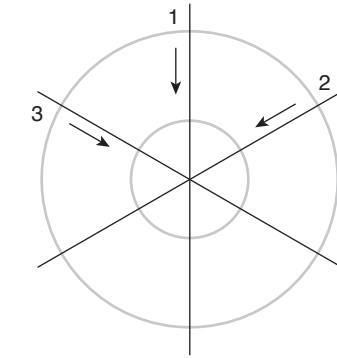

Scavenger Hunt

Check-off each item you find, and then sketch or write what it is.

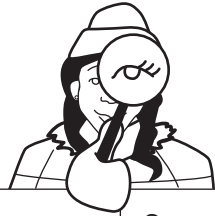

Something taller than you <input type="checkbox"/>	Something that needs air/oxygen to survive <input type="checkbox"/>	Something younger than yourself <input type="checkbox"/>
Something that you have not seen before <input type="checkbox"/>	Something with a scent <input type="checkbox"/>	Something with a seed <input type="checkbox"/>
Something that flies <input type="checkbox"/>	Something smaller than your thumb <input type="checkbox"/>	Something older than yourself <input type="checkbox"/>

Winter Phenology

The first time you discover each item below check it off and write down the date. Add your own things to watch for.

- Animal tracks are visible in the snow
- Squirrels find and eat hidden nuts
- Snow flea or spider on snow
- People ice skating on a pond or lake
- Indoor recess due to wind chill
- Frost forms on windows
- Sap visible on tree bark
- Breath visible outside
- People ice fishing
- More than six inches of snow falls
- Ice melts and open water appears on lakes
- Starlings show yellow on their bills
- Cardinal spring song, "what-cheer, cheer, cheer..."
- Brown leaves of oak trees begin falling
- First chipmunk emerges
- Icicles appear on buildings
- Snow squeaks under feet
- Other _____
- Other _____



Date:



Common Cloud Types

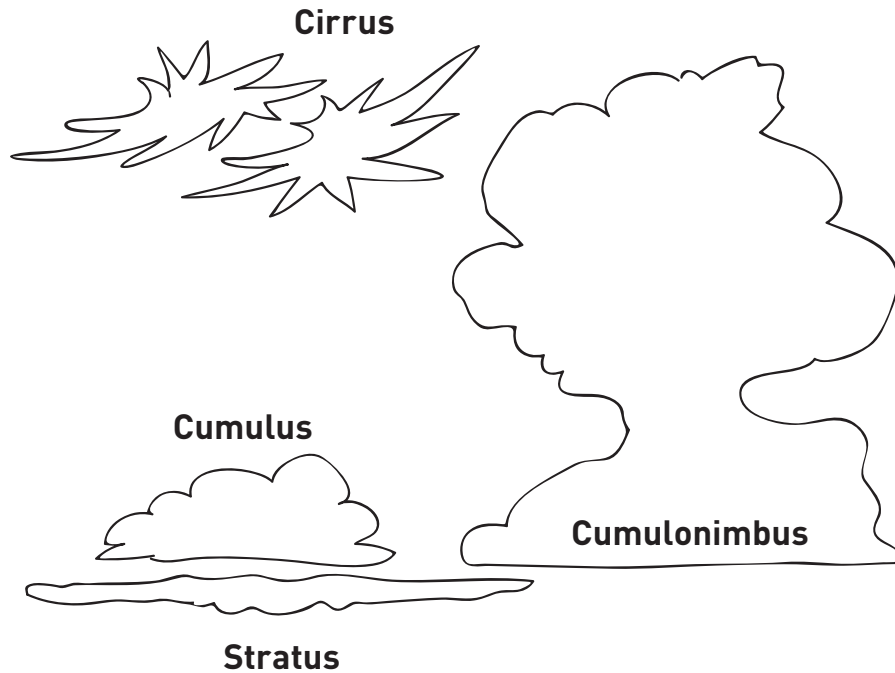

COOL WINTER FACT
10 inches of snow = 1 inch of rain

Winter Safety Tips

- Dress appropriately for the weather.
- Wear multiple layers of clothing to help keep you warm.
- Wear a hat and gloves or mittens.
- Participate in winter outdoor activities with a friend.
- Tell someone where you are going and when you will be back.
- Come inside periodically to warm up.
- Remove all wet clothing immediately and change to dry clothes if going back outdoors.
- Practice safety if going near a frozen stream, pond or lake. Ask an adult about the thickness of the ice before walking on it.

Can you think of any other tips? _____

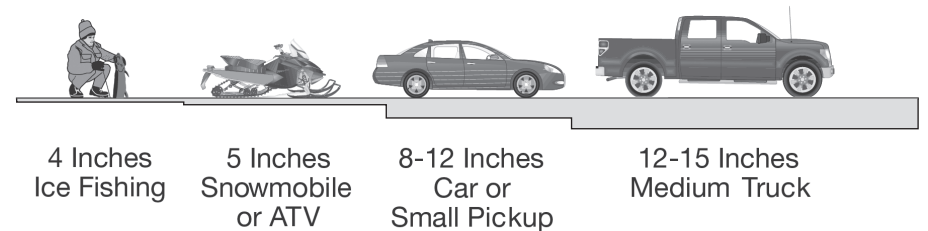

COOL WINTER FACT
Over 80% of the world's fresh water is in the form of snow or ice.

Winter Survival

Draw a line from the animal to how it survives or adapts to a Minnesota winter.

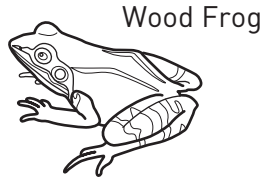

Wood Frog

Migrate

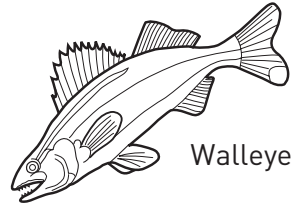

Walleye

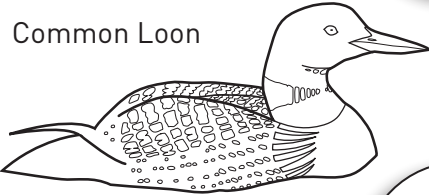

Common Loon

Black-capped Chickadee

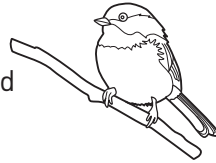

White-tailed Deer

Hibernate

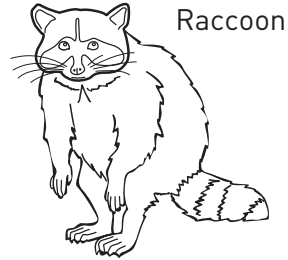

Raccoon

Monarch Butterfly

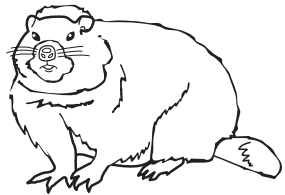

Woodchuck (Groundhog)

Stay active

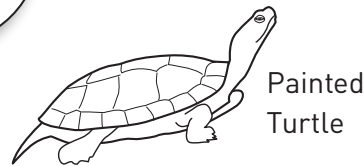

Painted Turtle



You

Go dormant



Gray Squirrel

Temperature

32 degrees Fahrenheit is freezing

0 degrees Celsius is freezing

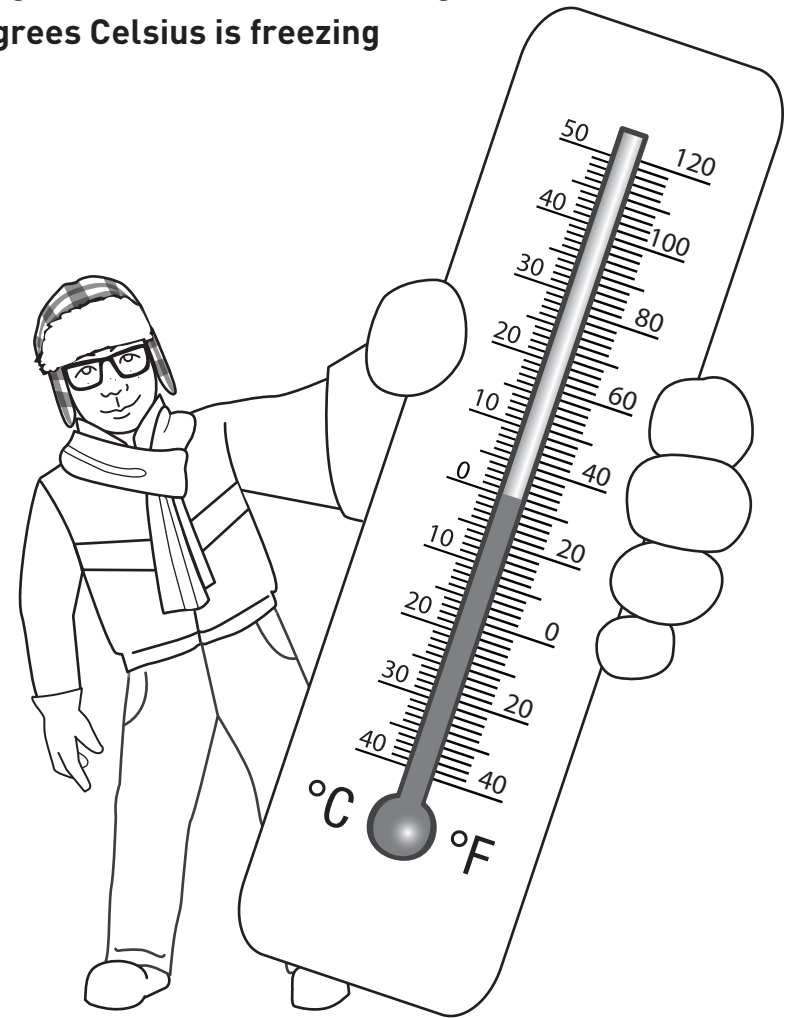

Conversion formulas

Fahrenheit to Celsius

$$^{\circ}\text{C} = (^{\circ}\text{F} - 32) \times \frac{5}{9}$$

or

$$^{\circ}\text{C} = (^{\circ}\text{F} - 32) \times .56$$

Celsius to Fahrenheit

$$^{\circ}\text{F} = ^{\circ}\text{C} \times \frac{9}{5} + 32$$

or

$$^{\circ}\text{F} = ^{\circ}\text{C} \times 1.8 + 32$$

Weather Tracker

Create a bar graph for temperature and wind speed. Enter a symbol for cloud conditions and precipitation.

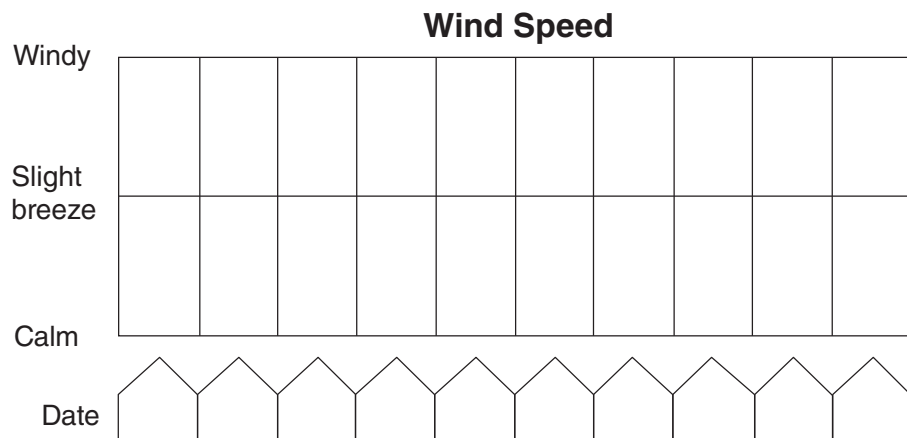
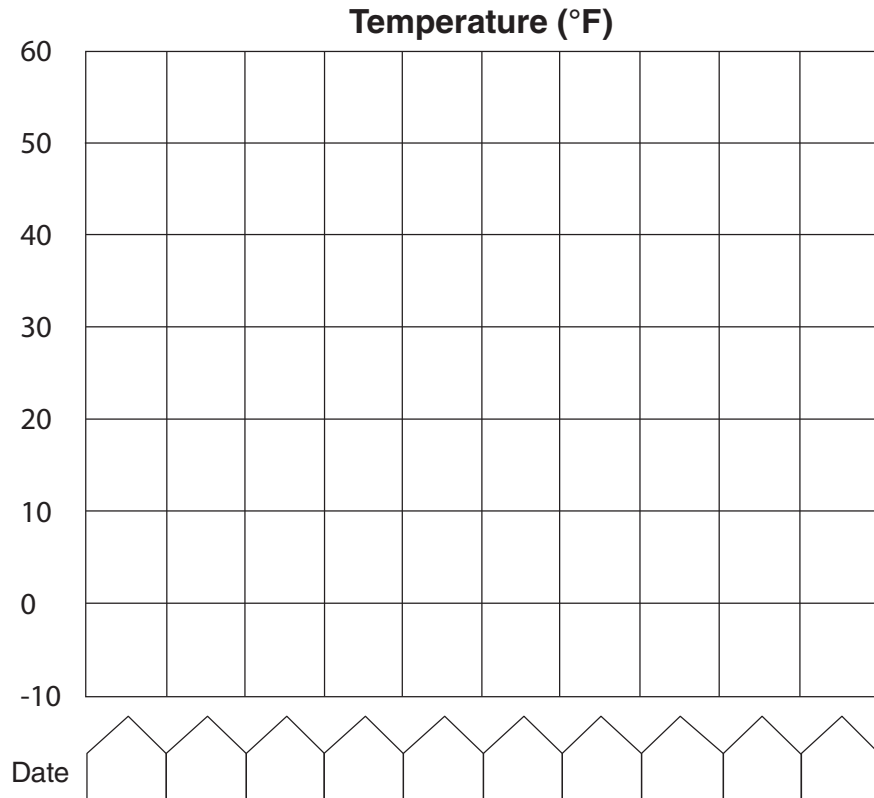

Nature Word Search

Find and circle the words below. Words can be found up, down, across, diagonally, forward, and backward.





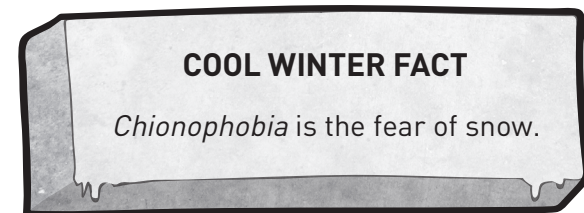





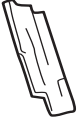











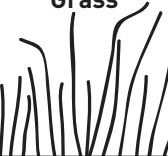

E	B	L	I	Z	Z	A	R	D	P	M	N
T	R	A	C	K	I	E	S	H	E	E	O
R	R	U	A	S	L	E	E	T	S	L	I
E	E	V	T	C	G	N	A	W	S	T	T
K	T	A	I	A	O	N	O	E	S	O	A
A	N	C	K	L	R	R	I	A	W	L	L
L	I	L	O	E	B	E	C	Q	W	D	U
F	W	G	B	Y	R	E	P	P	I	L	S
W	Y	I	O	U	R	Q	E	M	N	O	N
O	H	M	L	O	V	C	Z	Z	E	C	I
N	O	F	F	R	O	S	T	B	I	T	E
S	S	X	E	S	E	I	R	R	U	L	F

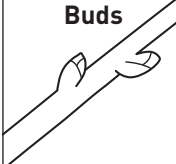
- | | | | |
|----------|------------|-----------|-------------|
| blizzard | frostbite | melt | temperature |
| browse | hibernate | phenology | track |
| cold | ice | sleet | winter |
| flurries | icicle | slippery | |
| forecast | insulation | snowflake | |



Winter Nature Bingo

Take a walk outside and try to find each one of the objects on the bingo board. Cross off the ones that you find. Yell "nature!" if you find five objects in a row or diagonally.

Bark 	Clouds 	Thermometer 	Winter clothes 	Snowflake 
Seeds 	Bird feeder 	Human footprint 	Ice 	Wind 
Bird 	Leaf 	Free 	Squirrel 	Grass 
Rocks 	Buds 	Coniferous tree 	Animal tracks 	Puddle 
Berries 	Icicles 	Animal scat 	Deciduous tree 	Other

COOL WINTER FACT

When hibernating a garter snake's heart rate drops to about six beats per minute.

Cloud Conditions



Cirrus



Cumulus













Stratus



Cumulonimbus



None

Date					
Date					

Precipitation



Rain













Sleet



Snow



None

Date					
Date					

Inside a Tree

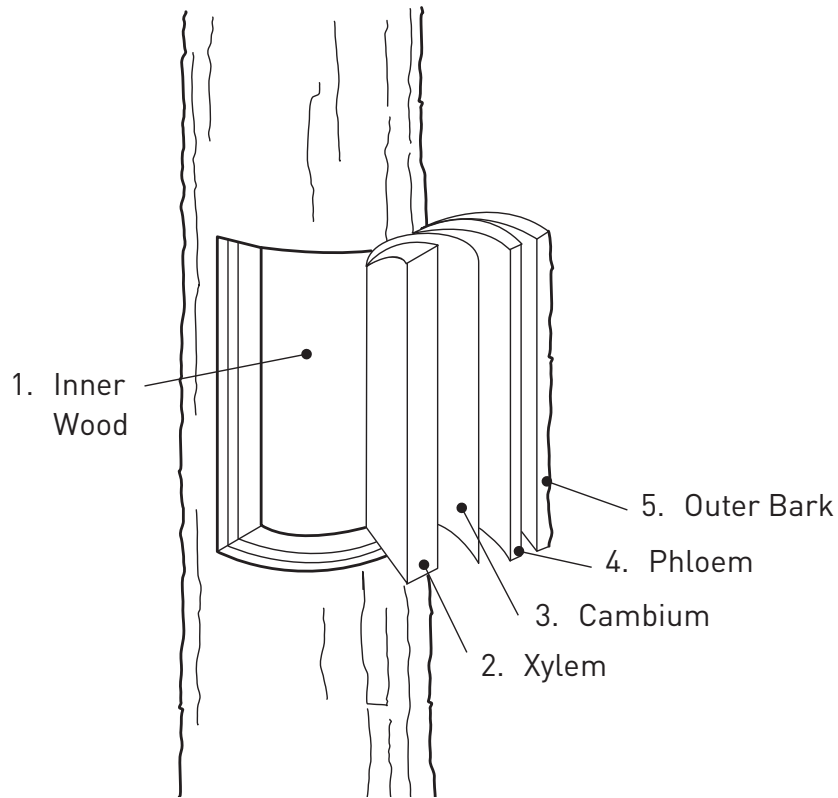

1. Inner Wood—supports tree, stores growing compounds and sugars
2. Xylem (zahy-luh m)—carries water and minerals from roots to leaves
3. Cambium (kam-bee-uh m)—makes trunk, branches and roots thicker
4. Phloem (floh-em)—carries food (sap) from leaves to rest of tree
5. Outer Bark—dead tissue that protects the tree from injury

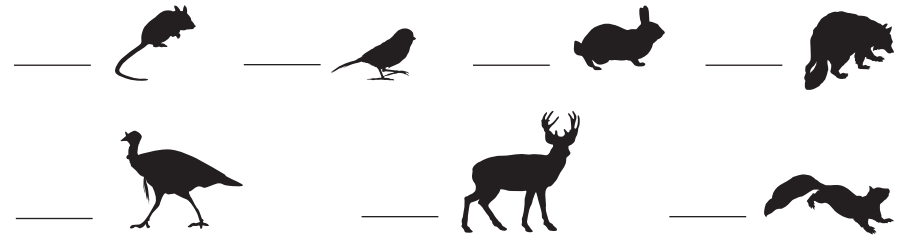

6. Wild Turkey



7. Red Fox



8. Striped Skunk



9. White-tailed Deer



10. Raccoon



Match the Tracks

Write the number of the track by the correct animal or bird shape.



1. Black-capped Chickadee



2. Cottontail Rabbit



3. Deer Mouse

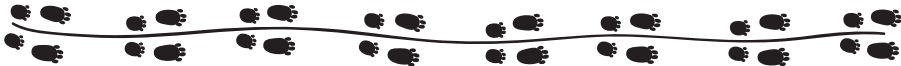

4. Gray Squirrel

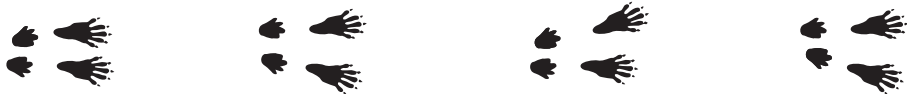

5. Gray Wolf



Tree Cookie

How many years old is this tree? _____

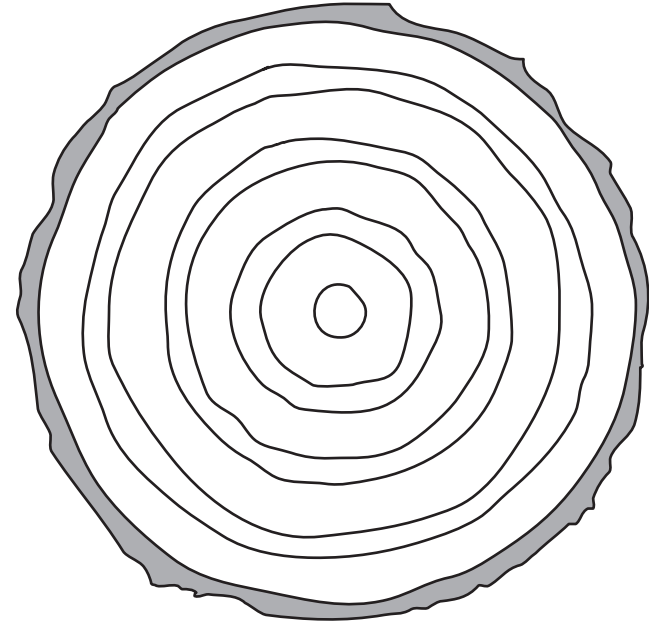

COOL WINTER FACT

World's largest stucco snowman found in North Saint Paul, Minnesota. An impressive 44 feet tall, built of 20 tons of concrete stucco in 1974.

Buds and Branches

Draw the items below.

**Opposite
branching**

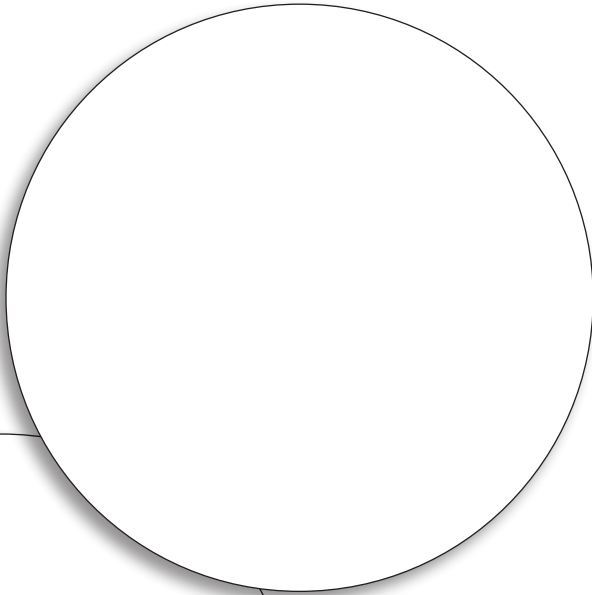

**Alternate
branching**

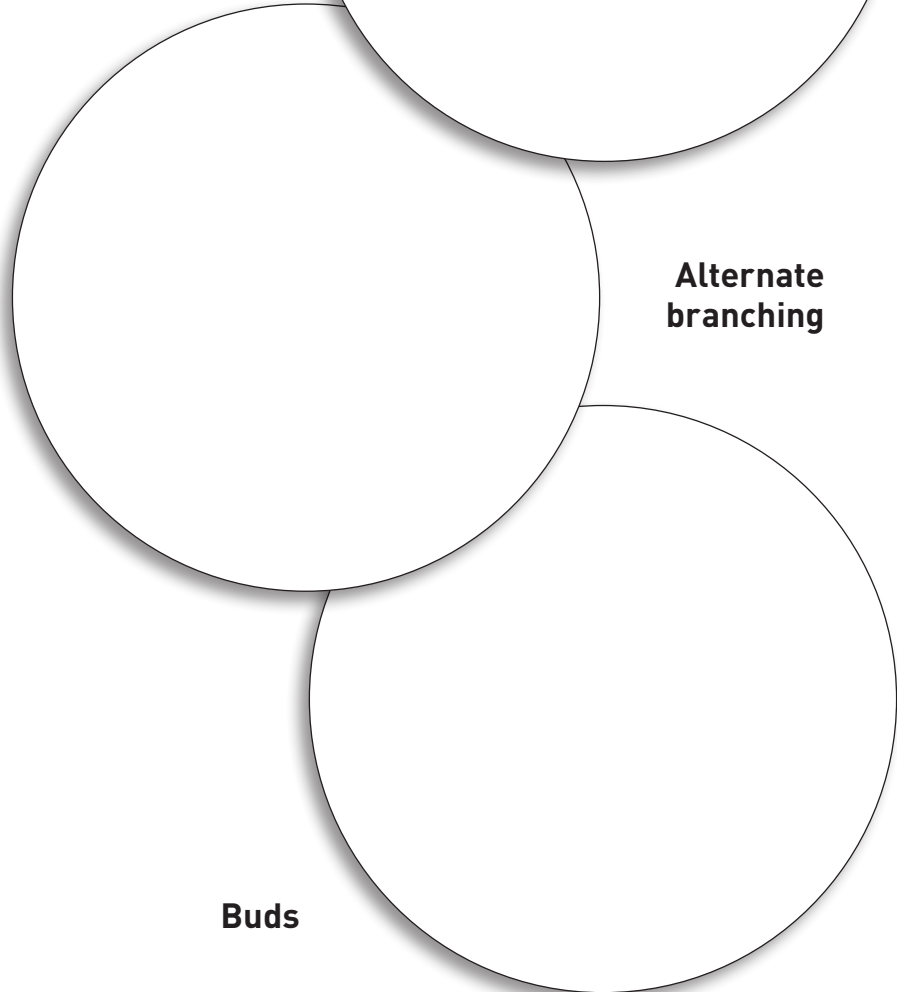

Buds

Field Guide

Field guides help you to identify plants and animals found in nature. There are many kinds, big and small, but all contain some basic information such as: common name, scientific name, a picture and description.

Create your own imaginary plant or animal field guide entry below.

A spiral-bound notebook page with a grid for a field guide entry. It includes sections for Common Name, Scientific Name, Description, a Picture box, and a Range Map box. The Range Map box contains an outline of the state of Minnesota.

Common Name

Scientific Name

Description

Picture

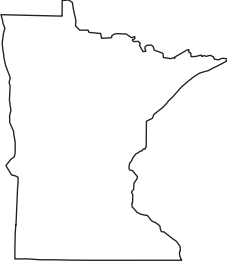

Range Map



UNIVERSITY OF MINNESOTA | EXTENSION



MINNESOTA MASTER NATURALIST

Minnesota Master Naturalist Explorers Winter Curriculum

ADAPTATION AND DORMANCY ARE KEYS TO SURVIVING A MINNESOTA WINTER



IN PARTNERSHIP WITH:



Minnesota Master Naturalist Explorers Winter Curriculum

ADAPTATION AND DORMANCY ARE KEYS TO SURVIVING A MINNESOTA WINTER

Authors:

Dawn Flinn, Education Coordinator, Minnesota Department of Natural Resources
Britt Forsberg, Explorers Coordinator, University of Minnesota Extension
Darren Lochner, Explorers Coordinator, University of Minnesota Extension

Curriculum Reviewers:

Sara Aker, Prior Lake Savage School District
Bev Blomgren, Minnesota Master Naturalist Volunteer
Pete Cleary, Naturalist, Dodge Nature Center
Cara Rieckenberg, Program Coordinator, School of Engineering and Arts

Partners/Sponsors:

Funding for this project was provided by the Minnesota Environment and Natural Resources Trust Fund as recommended by the Legislative-Citizen Commission on Minnesota Resources (LCCMR).

Portions of this material are reprinted with permission from Strauss, A.L., Homayoun, T., Meyer, R., Nippolt, P.L., Oberhauser, K., Peterson, C., Rager, A. & Young-Isebrand, E. (2015). Driven to Discover: Facilitator's Guide to Citizen Science. St. Paul, MN: University of Minnesota Extension. For more information about the Driven to Discover project, please visit www.extension.umn.edu/citizenscience.

Table of Contents

GETTING STARTED WITH EXPLORERS	4
ICE BREAKERS	5
ACTIVITIES	
NATURE JOURNALING	6
Constructing a Nature Journal	8
Onion Hike	8
Bicycle Spokes	8
NATURE OBSERVATION BASICS	9
Find a Pencil	10
Closer Look	10
Paint Chips	11
Slice of Silence	11
WINTER WEATHER WATCH	12
Snowflakes	14
Beaufort Scale	14
Find the Wind	14
WHAT IS WINTER?	15
Snowball Fight	16
Melting Contest	17
A Special Place Through the Seasons	18
INTRODUCTION TO A TREE	19
Know Your Branch	20
Connect the Branches	21
Meet a Tree	21
Tree Height	21
HOW ANIMALS SURVIVE WINTER	23
Frozen Frogs	25
Blubber Finger Test	26
Mitten Test	26
ANIMAL SIGNS	27
Just the Facts, Ma'am	29
Digital Hide and Seek	29
NATURE BINGO	30
Question Trail	30

EXPLORERS SCAVENGER HUNT

Nature Alphabet Search

Scavenger Hunt with a Twist

Nature Wristband

31

31

31

32

GETTING STARTED WITH EXPLORERS

The Minnesota Master Naturalist Explorers program, developed in 2011, worked with elementary students across the state of Minnesota to foster their curiosity about the world and provided an opportunity for Master Naturalist volunteers to share their knowledge and passion for the outdoors with youth. The Minnesota Master Naturalist program, a partnership between the University of Minnesota Extension and the Minnesota Department of Natural Resources, operated the Explorers program with generous support from the Legislative-Citizen Commission on Minnesota Resources (LCCMR) through the end of the grant period on June 30, 2015. The following materials were developed to assist Master Naturalist volunteers as they planned one hour sessions, once each week for four to eight weeks.

First Day Schedule

Arrive early and be prepared with supplies to set the room up. You should have familiarized yourself with the activities you will be conducting prior to this day.

Welcome individuals as they arrive. Attendance should be taken to assist with learning names. When all participants have arrived, introduce yourself. Share something interesting about yourself with the group. Introduce the Explorers Program and briefly mention that you are a volunteer with the Master Naturalist Program, a program sponsored by the Minnesota Department of Natural Resources and University of Minnesota Extension. It is helpful to share basic information about the structure of the program, “For the next six Mondays we will be learning about the outdoors and nature. Each week we will be spending some time outdoors so be sure you dress for the weather.”

Conduct an ice breaker activity to start the day.

Hand out Explorers backpacks, journals, tree cookie name tags, pencils and permanent markers. Have participants put their names on these items. Ask what it means to be an Explorer. Refer participants to page 1 of their journal for what Explorers do and what the rules for Explorers are.

Introduce the Minnesota Weatherguide Environment Calendar by showing the day’s date and the calendar features. Briefly mention that each week participants will be using the calendar to look at average temperature and phenological events. Phenology and the study of seasonal changes can be introduced on the first day.

It is recommended to take a brief hike around the schoolyard the first day. The hike can be used to make basic nature and weather observations.

Wrap up for the day. Ask the participants what they observed outdoors and summarize the topic of the day. Collect backpacks, journals, pencils and name tags. Take materials home with you in the materials bin.

Every Day

Consider bringing in a natural “object of the day” that relates to the topic you will be teaching about. This can be placed at the front of the room for the participants to look at as they come in to see if they can figure out what it is and what they will be exploring that day. Suggestions can be found at the beginning of each main activity.

Welcome participants, take attendance, hand out backpacks, journals, pencils and name tags.

Refer to the Minnesota Weatherguide Environment Calendar for weekly phenology, average temperatures and other relevant information.

ICE BREAKERS

The ice breaker activities are designed to be used at the beginning of each session or incorporated throughout the daily lessons. They can help participants feel comfortable with each other and the leader as well as help transition from the normal school day to the Explorers program.

Nature Makes Me Feel

Have everyone stand in a circle. Explain that each person should start by saying, “Nature and/or being outdoors makes me feel _____” and then respond with an expressive gesture. The leader gives an example, “Being outdoors make me feel HAPPY” and then he/she smiles or “Rain makes me want to jump in puddles” followed by jumping up and down. Adapt question based on the season and/or the current weather. When everyone has taken a turn, you can go around again with a different response.

Who Am I?

Place a name tag with an animal or plant found in Minnesota during the winter on the back of each individual. Participants are only permitted to ask one yes or no question per person about their animal or plant. They can go back through the group a second time and ask one question per person if the group is small or more time is needed. The goal is for the participant to guess the plant or animal on his or her back. This activity can also be done by giving only one participant the name of a Minnesota plant or animal and have the class ask questions to figure out the answer.

Animal Search

Prior to the participants’ arrival, come up with a list of five native Minnesota animals. This number might vary depending on the size of the group. Spread the participants out around the classroom or outdoors. Whisper the name of one of the animals into each participant’s ear. There should be at least two participants with the same animal name. When all players have been named, instruct them to find the rest of their “species” or fellow animals by making the sound or acting like the animal. The activity ends when all animals have found their fellow partners. Examples of animals might include owl, bear, wolf, wild turkey, frog or snake.

NATURE JOURNALING

Adapted from a *Keeping a Journal*, Monarch Lab, University of Minnesota.

Objective

To learn the basics of a nature journal.

Supplies

Explorers' nature journals

Pencils

Thermometer

Minnesota Weatherguide Environment Calendar

Objects of the Day: Examples of nature journals, plant and animal sketches and field guides

Magnifying glass (optional)

Camera (optional)

Background

Keeping records and taking measurements are important to being an Explorer. Good observations come from spending time looking at natural surroundings and making recordings through data collection and drawings. These recordings can be important for short and long term understanding of the environment.

The nature journal can be used to keep track of observed natural characteristics and changes in the environment made through written observations, recorded data and/or drawings. Observations might be based on the senses; sight, smell, touch or recorded data such temperature (actual vs. average), clouds types and wind. The journal is also a tool to record the seasonal phenology and changes around the schoolyard and surrounding neighborhood.

Emphasize that the participants do not need to be expert artists or writers to be good at journaling. Every journal entry is a good entry. Encourage participants to notice as many details as possible. Add labels to the drawings and note details like the date, location and weather. Provide examples of journal entries for the participants either from your own experience or in the Explorers' nature journal to help them get started.

Phenology is the science of seasonal changes and their effect on the natural world. A phenologist is someone who studies the changing of the seasons. Tracking events takes time and patience. First, you have to learn to be a good observer. Second, you have to become an accurate recorder of what you observe. Third, you have to become a critical thinker, finding links among the phenomena you are observing.

Activity

1. Explore and discuss the objects of the day.
2. Ask the participants why it is important to keep nature related records and measurements. What tools and supplies are needed? What would cause us to all have different observations?
3. Encourage participants to practice observation and description skills using words and drawings. Journal prompts are often helpful with weekly entries. Prompts might be sentences or key words that often help to initiate a journal entry. Refer to *Nature Observation* in the Explorers' nature

journal (page 3). The first time the journals are used, take a brief field trip around the schoolyard and record things the participants see. Share the list with each other.

4. One way to practice recording observations is to map the area of the schoolyard that will be visited during the Explorers program. Note key features like buildings, trees or paths. See *Draw a Map of Your Site* in the Explorers' journal for the mapping exercise (pages 4-5). The key can be used to draw symbols such as trees, shrubs or other landscape features to place on the map. The compass rose can be used to label the cardinal directions of North, South, East, and West. A good way to remember the letters and order on the compass rose is Never Eat Soggy Waffles. Consider sharing an aerial map of the schoolyard from a program such as Google Maps to show the participants another perspective of the area. Participants might also select a site in the schoolyard or a tree to observe once a week through the Explorers program. Drawings and photographs may be used to document the changes week by week. Assign a date to each of the recordings.
5. Record weekly weather observations such as temperature and general weather conditions such as precipitation and clouds on the *Weather Tracker* pages in journal (pages 10-11). Clouds may be classified by type or by the amount of coverage – clear, partly cloudy, mostly cloudy or overcast. Ask the participants how making weather observations is different when outside versus looking out the window or viewing photographs. Encourage the participants to compare the weather forecast printed in newspaper or on TV for a particular day with the actual weather conditions. Was the meteorologist accurate? Refer to the Minnesota Weatherguide Environment Calendar as a reference for average temperature data and weekly phenology.
6. Share the information presented in the phenology section of the Minnesota Weatherguide Environment Calendar. It is found after each month's calendar page. Define "phenology" and discuss seasonal changes to watch for in the upcoming month. Show participants the checklist of typical seasonal changes on the *Winter Phenology* page of the Explorers' nature journal and invite them to look for these changes as they go outside (page 7). Participants should observe and record any of the signs of winter in their journals and share with the group.
7. Other questions refer to the season. What are signs of winter? Refer to the Minnesota Weatherguide Environment Calendar and the Explorers' nature journal (page 7). Why it is important for naturalists and scientists to notice as many details as possible? Encourage participants to make general predictions of seasonal phenology. How do winter temperatures and hours of daylight/darkness change as the season changes and what effects do these changes have on plants, animals and weather in the area? What changes happen outdoors when winter arrives, temperatures decrease, etc.? Encourage the participants to observe changes as the seasons change from fall into winter and winter into spring on the *Phenology* page of the Explorers' nature journal (page 6).

Extensions

Constructing a Nature Journal

Objective: To construct a take-home nature journal.

Supplies: Colored cardstock paper, white paper, hole punch, straight stick, and a rubber band.

Activity: Construct nature journal by folding at least five sheets of white paper and place inside a folded cardstock cover. Punch two holes near the folded edge and wrap a rubber band around one end of the stick, guide the rubber band down through the hole then along the back of the journal and up through the second hole. Finally, wrap the rubber band around the other end of the stick. Illustrated directions can be found at www.makingbooks.com/elastic.shtml. The nature journal can be personalized with the participant's name and drawings. Journals can be constructed at any point during the Explorers Program. Encourage participants to make journal entries near their school, neighborhood or favorite outdoor location. Participants are also welcome to add photos to the journal along with a description of the object.

Onion Hike

Objective: To follow a trail using only your sense of smell.

Supplies: Scents that are easy to follow such as an onion. You may also use flavor extracts from the spice aisle at the grocery store.

Activity: Mark out a trail using only an onion (or other smells such as honey, maple, mint, anise, vanilla, etc.). Rub the scent on trees through the woods. Have participants try to follow the scent. You may consider hiding a treasure at the end of the trail as an added incentive. Ask participants if it was difficult to find the scent. What other scents did they discover? What makes this activity hard or easy? How do animals use their sense of smell in the winter? Have participants mark the scent trail on their Explorers' nature journal map and journal about what they discovered.

Bicycle Spokes

Objective: To challenge the sense of sight and hearing and change participants' perspectives on making observations.

Supplies: None

Activity: Have participants sit in a circle, then scoot directly back and lie down on their backs to form the shape of a wheel with spokes. Be silent for one to five minutes. Ask participants to describe what they heard. How many different sounds did you hear? What proportion of the sounds was non-human? Were you surprised or impressed by anything you heard? What did you see from this perspective? In what ways would you act differently if this was your perspective all the time? How do animals use their sense of hearing to survive in the winter? In their Explorers' nature journals, have participants write about their experiences lying under the tree.

NATURE OBSERVATION BASICS

Objective

To explore the schoolyard using multiple senses and record observations in the Explorers' journal.

Supplies

Explorers' nature journals

Pencils

Objects of the day: Ruler, magnifying glasses or binoculars

Linnaeus List or other field guides (optional)

Background

Making detailed observations of the environment is important to scientists, naturalists and everyday people. Using all the senses can result in a well-rounded understanding of the surroundings.

Every known living organism is classified and named by a set of rules and guidelines. Those rules are used by all scientists around the planet. The names scientists use are called scientific names, not common names.

Common names are the ones you might use when talking with your friends or family. You call your pet a dog or a cat which is the common name. Scientists call those animals by a set of several names like *Felis catus*. That's a domestic cat. Common names for organisms can be confusing because anyone can make them up, and they may apply to more than one species. For example, the mountain lion also has other common names such as panther, cougar, or puma. The scientific name for the mountain lion in North America is *Puma concolor*. *Puma concolor* refers to only one specific animal.

Scientific names follow a specific set of rules. Scientists use a two-name system called a binomial naming system. Scientists name animals and plants using the system that describes the genus and species of the organism. The first word is the genus and the second is the species. The first word is capitalized and the second is not. A binomial name means that it's made up of two words (binomial). Humans are scientifically named *Homo sapiens*. The name is always in Latin because when this naming process started, most people everywhere knew Latin. Scientific names help scientists to study organisms, especially when working with other scientists since they know which species is being discussed no matter where in the world they may be.

The descriptions used in field guides often refer to the characteristics such as color, size and shape in addition to feeding and nesting habits and the distribution or range of the plant or animal. The range map on the *Field Guide* page can be used to show where the organism is found in Minnesota (page 15).

Activity

1. Explore and discuss the objects of the day.
2. Discuss what tools (if any) are needed to make nature observations. How might the tools assist with making observations?
3. Ask the participants if they have made any recent nature observations.
4. Review the expectations/rules for going outside.

Tips to share with the participants:

- Wildlife is often easily scared by sudden movement and loud noises.
 - Participants should be within the view and be able to hear the instructor at all times.
 - Stay on the trails and pathways, unless told otherwise
 - Walk slowly.
 - Look up, down and all around. If something catches your interest, stop to sketch it or write about it.
5. Refer to *Nature Observation* in the Explorers' nature journal (page 3). Spread the participants throughout the schoolyard. Encourage them to complete the observation page by using their senses. Senses may be used at the same time or encourage them to isolate one sense at a time (i.e. blindfolding or closing eyes helps to focus on other senses). Gather the participants together and compare and contrast the lists.
 6. Ask the participants what unusual items they recorded. What sense resulted in the longest list? What sense was the most challenging to use? Encourage the participants to make nature observations when they go home and report their findings at the next gathering.
 7. Refer to the *Field Guide* page in the Explorers' nature journal to introduce field identification (page 15). Also show the participants examples of field guides such as the Linnaeus List. Discuss what features help to identify plants and animals and review what information is included in a typical field guide. The field guide page in the journal provides an opportunity for the participant to create an imaginary or real plant or animal. The field guide includes information such as common name, scientific name, description, picture and range map.

Extensions

Find a Pencil

Objective: To build observation skills and appreciation for camouflage.

Supplies: Pencil

Activity: Set boundaries and have participants line up along one edge of the playing area, facing away from the area. While the participants have their eyes closed, hide a pencil anywhere within the playing area. Once the pencil is hidden, the participants may look for it. If a person finds it, he or she should not give away (1) where the pencil is, and (2) that he or she knows where it is. Upon finding the pencil, the player should slowly, nonchalantly return to the starting line and act as overtly cool as possible. When most of the participants have found the pencil you may have the group point the pencil out for the remaining lookers. Play several rounds, hiding the pencil in harder places each time (on top of the leaves, behind the teacher's ear, stuck in a tree, tucked in the leader's shoe, etc.) Why was the pencil hard to find? What does this tell us about how careful our observations really are?

Closer Look

Objective: To amaze participants with the details not readily observable in nature and to practice using scientific tools.

Supplies: Magnifying lenses or binoculars

Activity: Review how to use the tools and give each individual or pair of participants binoculars or a magnifying lens and allow them to explore. Consider narrowing the focus of a hand lens exploration by challenging participants to discover the smallest living thing or something they never knew existed. Test the binoculars use by asking participants to read words or count something far away. In what ways do these tools help you explore nature? In what ways do they hinder your exploration?

Paint Chips

Objective: To challenge observation skills and increase awareness of nature's many details.

Supplies: Paint sample strips

Activity: Distribute paint sample strips from a hardware or paint store to each participant. Instruct each participant to find a color in nature that exactly matches a color on the paint sample. Did you find an exact match? Is an exact match possible? Why or why not? Were you surprised by how easy or challenging it was to find a match?

Slice of Silence

Objective: To establish a sense of place by using all senses to explore.

Supplies: None

Activity: Have participants find a quiet place to sit alone in a natural area. Give them at least ten minutes to sit and savor the quiet. Discuss the experience: What did you see? Hear? Smell? Touch? How did your experience change as time passed? You may also use blindfolds if available to help participants focus on their senses of hearing. Have participants list the different sounds - natural and those caused by humans. Ask how sounds could be different during different times of the day. With a partner or the whole group, have students share what they noticed when they closed their eyes

WINTER WEATHER WATCH

Objective

To determine and record basic weather observations such as cloud cover, precipitation and temperature.

Supplies

Explorers' nature journals

Pencils

Minnesota Weatherguide Environment Calendar

Cloud photos/drawings

Thermometer

Object of the day: Weather page cut from a newspaper or glass jar with frozen water to observe condensation as the ice melts

Background

Meteorologists are scientists who study the weather and the atmosphere. They are best known for forecasting the weather. In this activity, participants will make and record their own weather observations. They will also make connections between changes in the weather and seasonal changes in nature by using the Minnesota Weatherguide Environment Calendar.

High and low temperatures - by recording the daily high and low temperatures throughout the season and comparing them to the rest of the year, participants will see that fall and spring experience greater temperature differences than summer and winter months. By comparing the average temperature for the date and actual readings participants can make seasonal connections and know what kind of weather to expect.

The water cycle is the process through which water molecules move between the atmosphere and the Earth's surface. The main components are precipitation, condensation, evaporation, infiltration, and transpiration.

- Precipitation - moisture, often in the form of rain or snow, that falls to the ground
- Evaporation - when water molecules turn to vapor form and rise into the atmosphere
- Condensation - the opposite of evaporation, when water vapor in the air converts into liquid form
- Transpiration - when plants give off water vapor through tiny pores in their leaves
- Infiltration - the process of water soaking into the soil from the ground level

A cloud is made up of many tiny droplets of condensed water or ice crystals. Clouds help return water to the earth through condensation and precipitation.. Note that the warmer summer months usually result in more variety in cloud types.

A few common cloud types include:

- Cirrus - High wispy, thin clouds spread out high in the sky, horsetails

- Stratus – Clouds in low flat layers, spread out over most or all of the sky, fog
- Cumulus – Big puffy clouds, like giant cotton balls, reduce transpiration and evaporation
- Cumulonimbus – Clouds that can grow very large and tall, often bring rain and storms

The back of the Minnesota Weatherguide Environment calendar and the Explorers' nature journal provide photos of different cloud types. In addition, check out the following websites:

<http://cloudappreciationsociety.org/collecting/> has a helpful diagram of cloud types.

Web Weather for Kids – Clouds: <http://eo.ucar.edu/webweather/cloud3.html>

Snowflakes - are six-sided and are each made of up to 200 ice crystals. Snowflakes form in clouds where the temperature is below freezing. The ice crystals form around tiny bits of dirt that have been carried up into the atmosphere by the wind. As the snow crystals grow, they become heavier and fall toward the ground. In Minnesota snow is usually the main form of precipitation in the winter. Snow forms when the air is below freezing. If the air near the ground level is too warm, the snow will melt on its way down, changing to rain or freezing rain (often referred to as sleet). A blizzard is a long-lasting snowstorm with very strong winds and high amounts of snowfall. Three conditions must be met for a blizzard to form; cold air at the ground level, high moisture, and lift. Warm air must rise over cold air. www.weatherwizkids.com/weather-winter-storms.htm demonstrates how winter storms occur.

Activity

1. Explore and discuss the objects of the day.
2. Ask participants what they might typically observe in nature during this time of year. Refer to *Winter Phenology* checklist in the Explorers' nature journal (page 7). Explain that weather can affect how animals behave.
3. Highlight daily weather information along with phenology information for the week found in the Minnesota Weatherguide Environment Calendar. Refer back to this information when outside with the group.
4. With the help of participants, draw, label and discuss the main parts of a water cycle including: precipitation, condensation, evaporation, infiltration and transpiration. You can do this on a white board or large sheet of paper or in the Explorers' nature journal (page 8).
5. Discuss the water cycle's connection to weather, the movement of water and ways water moves through the cycle in the winter.
6. Have participants look at the different cloud types in their journals. In addition, show photos in the Minnesota Weatherguide Environment Calendar, or copies of cloud photos from websites. Discuss how clouds are formed. Ask where clouds fit in the water cycle. Which type of cloud brings us sleet? Snowstorms?
7. Go outside and have participants lie on their backs to observe the clouds. They can sketch their shapes in their journal. Ask participants how many different cloud types they observed. Are there differences in the clouds depending on the direction you look? Can you predict what the weather might be tonight? What types of clouds do you see? What else do you notice in the sky?
8. Use the Explorers' nature journal *Temperature* page to explain how to read a thermometer (page 9). Have one person from the group determine the actual temperature by looking at the thermometer you brought along. Have participants record the temperature in their journals. As

an instructor, you can keep a graph of daily temperatures and average daily temperatures found in the Minnesota Weatherguide Environment Calendar. Together, look at trends across the weeks of the Explorers program. Discuss how changes in temperature can affect organisms.

9. While outside also record wind speed, cloud conditions and precipitation for the day on the *Weather Tracker* pages in the Explorers' nature journal (pages 10-11). Compare and contrast conditions from week to week. Also, notice if there is a difference in the number of birds you see or other animal behaviors depending on the various weather conditions.
10. Gather items and head inside. Ask participants to watch the evening weather forecast during the week (or review the forecast online) then check to see if the meteorologist was correct with the forecast the following day. When you return the following week, discuss what participants noticed about the forecast during the week. Discuss what they noticed the following week.

Extensions

Snowflakes

Objective: To observe differences in snowflakes.

Supplies: Black construction paper, magnifying glasses

Activity: Put sheets of black paper in a freezer and remove right before conducting the activity. Take participants outside on a day it is snowing with a piece of black construction paper and a magnifying glass. Collect snowflakes as they are falling with the paper and look at them up close with a magnifying glass. Identify the shapes of snowflakes.

www.its.caltech.edu/~atomic/snowcrystals/class/class.htm is a helpful resource.

Beaufort Scale

Objective: To understand how to describe wind speed.

Supplies: Copy of Beaufort Scale from www.weatherwizkids.com/weather-wind.htm

Activity: Determine wind speed using the Beaufort Scale which is an empirical measure for the intensity of the weather based mainly on wind power. The wind speed is determined by making basic environmental observations.

Find the Wind

Objective: To determine which the direction the wind is traveling.

Supplies: Container of bubbles

Activity: Since we cannot see the wind participants, investigate the direction and speed of the wind using bubbles. Ask if participants can feel the breeze. How can you tell if it is a windy day? Have them look for different signs of the wind blowing (the movement of plants, branches on trees, exhaust in the air, etc.). Make a list of ways to "see" the wind. Now blow bubbles and try to determine which way the wind is blowing. Do the bubbles change direction? When? Why? Are the bubbles moving in the same direction as the clouds? Winds often blow in different directions. Warm air can blow in one direction and cold air in another. Check out www.weatherwizkids.com/weather-wind.htm to learn more about wind.

WHAT IS WINTER?

Objective

To understand why we have winter in Minnesota.

Supplies

Large, round object Earth such as a globe or beach ball to represent the

4 flashlights

Explorers' nature journals

Pencils

Watch or clock with a dial

Object of the Day: Globe

Background

Seasons are a result of Earth's relationship to the sun. In Minnesota, the less direct sunlight of the winter season brings many changes to nature. Many people think that winter happens because the Earth is tilted farther away from the sun, but the Earth is actually closer to the sun in winter. The Earth's path around the sun isn't a perfect circle; it is more of an oval (ellipse). This causes the Earth to be at different distances from the sun at different times during the year.

We have winter here in Minnesota because the northern hemisphere is tilted away from the sun during part of the year. This tilting results in less direct sunlight and radiation hitting the Earth's surface. With less of the sun's energy to absorb, temperatures drop and we experience the winter season. At the equator there is no distinct difference between the seasons since the sun's rays hit it at the same angle all year round. The winter solstice on December 21 is the longest night of the year and marks the meteorological first day of winter.

www.bigelow.org/virtual/handson/seasons_rotation.html has a helpful diagram to show the Earth's rotation.

Activity

1. Explore and discuss the object of the day.
2. Ask some questions about the winter season: What do you like about winter? What happens in the winter? What plants and animals do you see in the winter? What else do you see in the winter? What do you not see in the winter? Why do we have seasons on Earth? How are the seasons in the southern hemisphere different from the seasons where we are?
3. Have the participants arrange themselves in a circle and choose four volunteers to be the sun and give each a flashlight.
4. Have the sun participants stand with their backs together in the center of the circle and point their flashlight beams outward. Be careful not to shine the flashlights in the eyes of the participants around the circle.
5. Take the object you chose to represent the Earth and point out to participants where they currently are on the planet. The location can be marked by tape or by pointing your finger. Explain that the Earth is tipped on its axis.

6. Walk around the outside of the circle to demonstrate the Earth orbiting the Sun. Start in the spring, then move into summer, fall and finally end in winter.
7. Stop at different points around the circle, making sure you are in the path of a flashlight beam. Point out which month you are in and how much light your position on the globe is receiving during each season.
8. Relate this new knowledge to the beginning discussion and ask participants questions to evaluate their understanding of what causes the changes we see in winter. If time, reinforce the information presented in the demonstrations through diagrams or video. Helpful videos can be found at www.youtube.com/watch?v=EPJ_HUcg8L07 and www.youtube.com/watch?v=NydSuHoQZqk.
9. Go outside and show how to generally determine which direction is south. Using a watch with a dial, point the hour hand at the sun. Half way between the hour hand and the 12 on the watch will be south. At night if there is a crescent moon you can draw an imaginary line between each crescent point. Follow the line to the ground and where it touches is south.
10. If participants haven't already, enter the directions north, south, east and west onto their nature journal map in the lower right hand corner (pages 4-5). If already entered, see if they put south in the correct location.
11. Have participants sit or stand in a circle, representing the sun. Pick one person to be the earth. Have the earth walk around the sun tapping people on the head and say "solstice, solstice, solstice." When the earth taps someone on the head and says "equinox," the person tries to tag the earth as he or she runs around sun and back into the empty spot. Play again as time permits.
12. Back in the classroom, show that the winter and summer solstices (usually December 21 and June 21) occur when the earth is closest to the sun and the spring and fall equinoxes (usually March 20 and September 22) are when the earth is the farthest away from the sun. Ask participants if they think the daylight is getting longer or shorter at this time. Why or why not?

Extensions

Extensions adapted from *ecotime*, Jeffers Foundation.

Snowball Fight

Objective: To understand different descriptions and views of snow.

Supplies: Paper and pencils

Activity: Give each participant a piece of white paper (scratch paper is acceptable). Ask participants to write a word on each sheet to describe winter or snow. Make sure that they print the words large enough and legible. Next, participants will crumple the paper into a snowball, stand up and throw the snowballs at each other on your signal. Have participants pick up the nearest snowball. Go around the circle to have participants share the one word description for winter or snow with the group. Write the responses on the board and discuss. Which words could be used to describe winter and snow today? Are there additional words to describe winter and snow that were not included in the snowball fight?

Melting Contest - Ice and Salt

Objective: To understand how salt affects ice.

Supplies: Ice cubes, two plates and salt

Activity: The freezing point of water is lowered when it is mixed with salt. During the winter we often apply salt to the roadways and sidewalks to prevent or melt ice. This experiment involves racing two ice cubes to see which will become a pool of water first. Place an ice cube or cup of snow on each plate. Make sure each ice cube or pile of snow is the same size. Sprinkle salt onto one of the ice cubes. Ask participants to make predictions. Which ice cube will melt faster?

A Special Place Through the Seasons

Objective: To observe the seasonal changes in one particular place.

Supplies: Explorers' nature journals, pencil, digital camera (optional)

Activity: Select a special place in the neighborhood or special tree and take a photograph or make a drawing during each season of the year. Record the dates in a journal along with photographs or drawings. Describe the changes noticed throughout the year in and around the area selected. Consider making journal entries more than one time during each season.

INTRODUCTION TO A TREE

Objective

To understand how to observe and record the different types of trees growing in the schoolyard and compare their characteristics.

Supplies

Explorers' nature journals

Pencils

Magnifying glasses

Rulers

Branches with both opposite and alternate arrangements as well as buds

Tree cookie name tags, large tree cookie or photo of tree cookie

Objects of the Day: Deciduous and coniferous tree branches with buds

Tree field guides (optional)

Background

Trees can be found on most schoolyards and are a great way to watch the season progress as daylight gets longer. The main part of this activity will occur on the first visit but throughout the weeks make sure to take a little time every session to have participants observe their trees, looking for any changes and noting them in their journals.

There are two main types of trees. In general, deciduous trees lose all of their leaves in one season and coniferous trees keep their sharp and narrow leaves called needles on the tree year-round. Coniferous trees produce cones that carry their seeds. In fall, deciduous trees begin to shed their leaves to conserve energy and limit damage to the tree from the snow and storms during the winter.

Many people think you can't tell trees apart once the leaves have fallen off. However, by closely examining the buds and bark, you are often able to identify trees.

The main parts of the inside of a tree include:

- inner wood – supports the tree, stores growing compounds and sugars
- xylem – carries water and minerals from roots to leaves
- cambium – makes trunk, branches and roots thicker
- phloem – carries food (sap) from leaves to rest of tree
- outer bark – dead tissue that protects the tree from injury (much like human skin).

More information can be found at

www.mndnr.gov/forestry/education/treeforallseasons/index.html

Activity

1. Explore and discuss the objects of the day.

2. Ask participants how they might identify trees in the winter. Make a list of tree features that may be helpful in identification: height, diameter, bark texture, leaves, shape etc.
3. Point to a tree or show a winter tree photo and ask participants to make some general observations. How might those features change in the spring, summer, and fall seasons? How many different kinds of trees could they find on the school grounds? Have them write their prediction in their Explorers' nature journals.
4. Show and discuss the differences between a deciduous and coniferous tree.
5. Open to *Buds and Branches* in the Explorers' nature journal (page 14). Using real branches, show the difference between an opposite and alternate branch and have participants make a quick sketch of each in the appropriate circle. Then show at least two different kinds of winter buds and have participants sketch one in the bottom circle.
6. Have each participant predict the number of kinds of trees in the schoolyard and write it in their journals. Go outside and give participants five to ten minutes to find and count as many different kinds (not numbers) of trees as they can within the boundaries you set. When time is up call them back in and have them write their answer in the Explorers' nature journals. How close were they to their predictions?
7. Group participants in pairs and have them select a tree to adopt in the schoolyard. Pass out rulers and magnifying glasses for participants to make detailed observations.
8. Ask participants to record and sketch their trees on a *Nature Observations/Field Sketches* page in their Explorers' nature journals (pages 24 - 26). They should include: leaves/or buds (color, shape, size, and other observations), bark (color, shape, size, and other observations), tree height and shape and any other observations. Make sure participants write down the date of their observations. If they have made a map in their journal of the schoolyard add the location of their tree to this map (pages 4-5).
9. If time, include other observations like what does the tree smell and feel like? What signs are there that animals have used the tree? Do a bark rubbing. Determine the circumference (C) around the tree. Using a flexible tape measure, measure to the nearest inch the distance around a tree at a point 4½ feet up from the ground (C). Then convert this number into the tree's diameter (D) using one of these formulas $D = C \times .3183$ or $D = C/3.1416$.
10. Take a few minutes every week to have participants revisit their tree and record any changes they see.
11. Gather participants together and return to the classroom. Using their tree cookie name tags, refer to *Inside a Tree* in the Explorers' nature journal and review the different parts, how to pronounce them and what they do (page 12). Could they see any of these parts on their tree? Why or why not? Do they think the phloem is active now? Why or why not? What about the xylem?
12. Ask participants to notice the different trees that they see on their way home or when traveling to other places.

Extensions

Know Your Branch

Objective: To recognize characteristics of branches by touch.

Supplies: One tree branch for each participant, blindfolds (optional)

Activity: Place a stack of branches on a table or the floor. Ask each participant to be blindfolded or close his or her eyes and find a branch. Once each participant has a branch, ask them to get to know the branches by feeling and recognizing characteristics like length, branching or texture. Place the branches back in the middle, have the participants take the blindfolds off and then find the branch they were holding. The branches can be a mix of deciduous and evergreen species, shapes and sizes.

Connect the Branches

Objective: To closely observe tree branches and pay attention to all characteristics.

Supplies: Pairs of branches

Activity: Before the Explorers session, cut branches of several different tree species in half. Assign one branch to a participant and ask him or her to find its match in the classroom by using clues like color and texture of bark, branching, buds, shape or size.

Meet a Tree

Objective: To identify trees using senses other than sight.

Supplies: Blindfolds

Activity: In groups of two or three, participants blindfold one member of their group and carefully lead the person to a tree. The blindfolded person gets to know the tree by feeling, smelling, listening to it, feeling for the tree's neighbors, etc. When the blindfolded person is confident that he or she knows the tree, the rest of the group leads the blindfolded person back to the starting point. After removing the blindfold, the newly sighted person attempts to relocate his or her tree. Rotate jobs until everyone has had a turn. Were participants able to find their trees? How did participants identify their trees? How are some trees different from other trees?

Tree Height

Adapted from *Teachers' Guide to Arbor Month*, Minnesota Department of Natural Resources

Objective: To estimate the height of a tree using ratios.

Supplies: Twelve inch ruler, masking tape, measuring tape

Activity: Height is the hardest tree measurement to obtain. Use a ruler and follow the instructions below to estimate the height of trees in the schoolyard.

1. On a 12-inch ruler, mark the 1-inch and 10-inch lines with masking tape.
2. Group participants in pairs.
3. Person A stands at the base of the tree.
4. Person B, while holding the ruler up in front of their eyes at arm length, moves back until they can see the whole tree from top to bottom between the 0-inch and the 10-inch mark on the ruler.
5. Person B then moves the ruler until the base of the tree is exactly at 0-inches and the top of the tree is sighted exactly at 10-inches.

6. Person B sights out from the ruler's 1-inch mark to a point on the trunk above the base.
7. Person A marks this spot on the trunk with tape.
8. Measure the distance from the base of the tree to the 1-inch mark (X) on the tree.
9. Together, multiply by 10 to get an approximate height of the tree.

HOW ANIMALS SURVIVE WINTER

Adapted from *Winter Wildlife*, Edwards YMCA Camp and *How Animals Survive in Winter*, *Schoolyard Ecology Explorations*, University of Minnesota.

Objective

To understand ways animals survive a Minnesota winter.

Supplies

Explorers' nature journals

Pencils

Sunflower seeds or other decomposable item, enough for each child to receive at least 20

Large sheet of paper

Marker

Woodchuck drawing

Linnaeus List field guides

Plastic sandwich bags

Vegetable shortening

Objects of the Day: Pictures of different animal homes/shelters, samples of animal fur

Background

In temperate regions, animals must contend with challenging environmental conditions in winter when temperatures are cold and food is scarce. They have developed several strategies for winter survival.

Some animals migrate, leaving the adverse conditions behind and moving to other regions where the conditions are more suitable. Migration is defined as the regular movement of animals over relatively long distances. Many animals migrate great distances to escape harsh winter conditions.

Some animals remain active, often developing thicker coats like deer and rabbits or huddling together to keep each other warm like honey bees clustering in the winter hive. They may also eat food they have stored for the winter like gray squirrels. A few animals like the snowshoe hare and short-tailed weasel change color from brown in the summer to white in the winter to help them camouflage with their surroundings.

A unique and not completely understood strategy for survival is hibernation. Hibernation is defined as a state in which an animal's metabolic rate is reduced to a minimum and the animal enters a deep sleep, surviving on food reserves (fats) stored in the body. Scientists have found a special substance in the blood of hibernating animals called HIT (Hibernation Inducement Trigger) that they believe controls hibernation. A woodchuck's heart rate goes from 80 beats per minute when active to four or five beats per minute when in hibernation. Its body temperature drops from 98° F to 38° F. And, the woodchuck's incisors, which grow continuously and are kept short by all the gnawing it does, quit growing during hibernation. True hibernators do get up every few weeks to nibble on food, and in the case of the woodchuck, use an underground toilet room.

In comparison, dormancy occurs when an organism's metabolic rate drops to a minimum but it keeps a relatively high body temperature, usually due to its large size. As commonly mislabeled,

bears are not true hibernators because they are able to reproduce and are easily awakened during winter. Black bears enter dormancy rather than deep hibernation, and although their respiration rate drops to two to three times per minute, their body temperature only drops to around 95 °F.

The following summarizes what some Minnesota animals do to survive in winter:

Hibernate -woodchuck (groundhog), ground squirrels, some bats, chipmunk, frogs, turtles, and some bats.

Dormant -black bear, skunk, raccoon, most insects, and mussels.

Migrate - many birds, some bats, monarch butterflies.

Active: some birds, some bats, red squirrel, gray squirrel, cottontail rabbit, red fox, gray fox, white-tailed deer and fish.

Note: A few birds may use more than one strategy. For example, the American robin usually migrates but some are active in parts of Minnesota during the winter if there is enough food and water.

Activity

1. Explore and discuss the objects of the day.
2. Ask the participants what they and their families do differently in winter to survive the cold weather and snow. Are there animals that do the same things to survive winter? Discuss animal responses to winter with your participants, using the background information provided above or other resources.
3. Describe the four major strategies for survival: dormancy, hibernation, remaining active, and migration. Write these strategies on a large sheet of paper.
4. In their Explorers' nature journals, ask participants to write down the four main survival strategies and then list at least one Minnesota animal they think uses each strategy.
5. As group, record ideas on the large sheet of paper (you can save this sheet to refer to when doing the *Animal Signs*). When all the ideas are gathered, discuss which animals do and do not hibernate. You may want to suggest animals if participants do not list all the categories. Ask why they think an animal would hibernate. Share specifically what happens to the woodchuck's body during winter hibernation compared to the summer.
6. Discuss how part of getting ready for hibernation is eating a lot of food before winter in order to build up fat reserves. Fat will be used as food during hibernation to help keep the animal alive and also as insulation. If the animal does not store enough fat it may not survive. Note: Not all animals that hibernate store fat; a chipmunk is one example of an animal that does not store fat when it hibernates.
7. Play the food gathering game. It is preferable to do this outside but it also can be done inside. Tell the participants that they will each have the chance to be a woodchuck preparing for hibernation and that they need to find and eat enough food in order to survive the winter. In Minnesota woodchucks start preparing early by eating green plants, vegetables and fruits throughout the summer to fatten up. Hibernation then kicks in during the fall when temperatures drop and food becomes unavailable.
8. Split the group in half. Half will be the woodchucks and the other half will be the food hidiers. Define the area where the food can be hidden; keep the range fairly small.

9. Give each of the hidere 10 pieces of food (you can use sunflower seeds, corn, or any other decomposable item). Have the woodchucks close their eyes and turn their backs to the defined area. Allow the hidere to spread out their food for one minute then call them back.
10. The woodchucks will now have a few minutes to find as many pieces of food as they can. They must stop when they are called back to the starting point.
11. Have the woodchucks count how many food items they found. If they collected 10 or more they survived the winter, if not they died.
12. Switch groups and play again. Play as many times as you would like. You may want to increase the amount of food each time, in theory allowing more woodchucks to survive. Or decrease the amount of food and compare. Discuss the importance of food for survival.
13. Place a snack size plastic bag full of vegetable shortening on the snow along with an empty snack bag. Have the participants feel the top of the bags, pressing gently toward the snow. Ask if there is a difference in temperature. Which one is warmer? Why? Fat isn't just used for food, it also provides insulation for the animal in the winter. What do you use as insulation in the winter for your bodies? Are certain types of clothes better than others? What would happen to us on a cold winter day if we were outside all day without proper clothing?
14. To wrap up ask what else is important for the survival of a hibernating animal. Discuss how habitat and finding a place to hibernate is very important. If their shelter isn't well protected they could be exposed to the elements, harming their chances of survival from either exposure to the cold or predators.
15. If time, have participants run, skip or hop either in place or around the area pretending they are looking for shelter and also to warm up (and get out some energy). Visit any real shelters that may be discovered (tunnels, squirrel nest, tree holes, etc.)
16. Gather activity materials and return indoors.

Extensions

Frozen Frogs

Adapted from *Winter Wildlife*, Edwards YMCA Camp

Objective: To understand how frogs survive winter.

Supplies: Frogs & Toads of Minnesota poster, lime green gelatin, hot water, small paper cups or plastic snack bags, tablespoon

Activity: Ask what frogs and toads do in the winter? Show the Minnesota DNR Frogs & Toads of Minnesota poster. Explain how frogs hibernate either on (not under) the mud at the bottom of a body of water, or go under the ground or leaf litter. Some frogs like the wood frog, gray tree frog, spring peeper and striped chorus frog hibernate on land and actually freeze solid except for their vital organs which contain a special substance that acts as an antifreeze.

Follow instructions for making a small box of lime green gelatin (hot tap water works instead of boiling). Fill a small paper cup or snack size plastic bag with about one tablespoon of liquid gelatin. You can make the gelatin before class starts but must keep it at room temperature. Tell participants they are frogs and need to find a good spot to hibernate without having their bodies freeze solid. Have them place their "frogs" outside, then collect them after 20 minutes or longer. (Note: Frogs partially gel after about 20 minutes in 18 °F temperature). If some liquid still remains, their frog

survived hibernation. For more information, read www.scientificamerican.com/article.cfm?id=how-do-frogs-survive-wint

Blubber Finger Test

Adapted from *ecotime*, Jeffers Foundation.

Objective: To understand how fat insulates.

Supplies: Two bowls, ice, water and vegetable shortening such as Crisco

Activity: Fill two bowls equally with ice and water and let them stand for five minutes. As they sit, apply vegetable shortening to one of the participant's pointer fingers to represent blubber (animal fat) and leave the second pointer finger uncovered. Place the participant's two pointer fingers into a bowl and see which finger he or she can keep in longer. Participants should find that the finger covered with "fat" can stay in the cold water longer, just as the fat on hibernating animals protects them from winter chill.

Mitten Test

Adapted from *ecotime*, Jeffers Foundation.

Objective: To understand how warm-blooded animals are able to produce their own body heat.

Supplies: Pair of mittens, three thermometers

Activity: This activity has a direct connection to how humans and animals keep warm during the winter months. You will compare the temperature in the room that that in a mitten and human body temperature. Ask participants where the temperature will be the warmest. Determine the room temperature by placing a thermometer on a desk or table. At the same time place one thermometer in one mitten and another in the other mitten along with a participant's hand. Wait two minutes and record the temperature in each location. Compare your answers. Talk about how humans and animals keep warm in winter. Would the results be the same if a bird or a fish wore mittens?

ANIMAL SIGNS

Adapted from *Tracks and Traces* Vermont Institute of Natural Science (VINS) www.VINSweb.org and *Animal Signs*, Upham Woods Outdoor Learning Center.

Objective

To identify signs of animal activity in the winter.

Supplies

Explorers' nature journals

Pencils

Colored ground flags (5 each of two colors preferred)

Animal track sheets

Ruler

Objects of the day: Animal-chewed twigs

Animal tracks field guide (optional)

Whistle (optional)

Hula hoops or bright colored yarn (optional)

Background

Animals are often hard to see, even in the winter. Learning to identify their tracks and signs is a fun way to discover the animals living in your area as well as what they have been up to. Snow cover can provide a great opportunity to find tracks, tunnels, food and other items that may not be as visible the rest of the year. Plus, all you need are your senses and some basic tools.

There are five main categories of animal signs to look for including: tracks and trails, homes, eat marks (browse on vegetation), scat (poop) and urine, and body parts. Tracks are the prints animals leave behind and their trail is the prints put together; homes could include leafy squirrel nests, mouse nests or tunnels, holes in trees or cocoons. Eat marks include cracked seeds and nuts, chewed branches and small holes in trees. Scat and urine is of course poop and pee. Body parts could include pieces of fur or bones from prey animals.

The four main track patterns to look for include:

- Galloping - push off with their front feet and then swing their two back feet around so that they land in front and a little outside of the prints made by the smaller front feet (mice, squirrels, rabbits)
- Bounding - land with their front feet planted nearly side by side, the two back feet fall into the prints made by the front feet (weasel, mink, otter)
- Waddling - alternating big-little pattern as they place their large hind feet next to their smaller front footprints (raccoons, porcupines)
- Walking/Trotting - alternates right and left feet, placing the hind feet in the prints made by the front feet making a nearly straight line of single prints

Animal track activity sheets can be found at
http://files.mndnr.gov/education_safety/education/project_wild/animal-tracks.pdf

Who Made These Tracks? www.mndnr.gov/young_naturalists/tracks/index.html

Activity

1. Explore and discuss the objects of the day.
2. Before participants arrive check the area for animal signs and make notes of where they can be found. Look for tracks, chewed twigs, nests, tunnels and other signs. Mark these with colored yarn or hula hoops (optional).
3. From the list made during the activity, *How Animals Survive the Winter*, review the animals that are active or dormant in the winter. Are there any more active animals to add to the list? These are the animals that will be leaving the tracks and other signs we will be looking for.
4. Introduce animal signs and tracks to the group. Explain that “tracking” is looking for and following animal signs. It has been an important part of human survival for thousands of years.
5. Using the *Match the Tracks* in the Explorers’ nature journal, review the four main track patterns animals create: galloping, bounding, waddling and walking/trotting (pages 16-17). You may want to have the participants try to move in these different patterns.
6. Emphasizing tracks you found in the area along with the journal and additional track sheets, share how to identify some common animal tracks like rabbit, squirrel, mouse, songbirds, etc. Look at size, shape, track pattern and location when trying to identify a track.
7. Share how tracking is like solving a mystery. When trying to identify a track, ask yourself questions. Where is the track? Is it in the forest, on the playground or in a field? Certain animals are more likely to be found in the habitats they prefer. How big is the track? Remember freezing and thawing and wind can change or cover parts of a track. What is the track pattern? All these things will help you narrow down the answer.
8. Besides tracks you may also encounter other signs of animals. Ask participants for their ideas of what these signs could be. Show browsed deer and rabbit twigs as an example of what to look for when they are outside. Note: You may also choose to bring in your own real animal signs to share such as scat.
9. Divide the class into two groups. Give each group five colored flags (one color per group). Explain that they should try to mark at least one animal track, one animal home and one source of food. For the last two flags they can mark any animal signs they would like. Have each participant bring their Explorers’ journal and a pencil. The instructor should also bring along the extra track sheets, ruler and optional field guide.
10. Allow each group time to find and mark their animal signs then gather them back into one large group.
11. As a large group, visit as many marked areas as you have time for, alternating between the two colors and gathering the flags as you move along. Discuss what the participants found. Encourage them to use their journal, track sheets and a ruler to help identify any tracks. They can also draw what was found. Are there any stories the tracks and signs are telling you such as where the animal lives or what it was doing?
12. If there is time, finish by visiting the animal signs you found before class. Have a few participants gather any leftover flags.

13. Wrap up with some discussion questions. How can knowing about animal signs be helpful? What careers or activities involve looking for animal signs today? Challenge the participants to find at least one animal sign near their home and show it to another person.

Extensions

Just the Facts, Ma'am

Objective: To be able to made detailed observations to describe an object.

Supplies: One natural object per person, Explorers' nature journals, and pencils

Activity: Give participants natural objects such as rocks, sticks, pinecones, etc. Instruct them to write twelve different ways to describe their object. They should be as precise and detailed as possible. When everyone is finished, place natural objects in the center of the group. Have one person take a list and read one description at a time. The group should try to guess which object is being described. Try to match all description lists with their respective natural objects. Why was it easy to guess some objects, harder to guess others? Was it difficult to come up with twelve descriptors for your object?

Digital Hide and Seek

Objective: To improve observation skills.

Supplies: Digital camera

Activity: Have one participant take a digital photo of something at your site, then have the other participants try to find the real object. Was it difficult to find what was in the photo? What landmarks could you include in your photo to help others find the object? How does this activity help you think like a scientist?

NATURE BINGO

Objective

To explore the schoolyard using a nature bingo card.

Supplies

Explorers' nature journals

Pencil

Field identification guide (optional)

Background

Nature bingo encourages participants to summarize what they observed over the past several weeks. Nature bingo is a good way to wrap up the seasonal Explorers Program.

Activity

1. A bingo card is included with the Explorers' nature journal (page 18). As an alternative, each square of a blank bingo card can be filled in with items that the participants have observed throughout the program. Include a variety of plants, animals and other natural features of the schoolyard. The images of the items can be copied from clipart or the text/name can be included and the participant can sketch each item found.
2. Before going outside review each of the items included on the bingo card.
3. The goal is to get bingo (five squares in a row) or blackout (all spaces crossed off) on the card.
4. Review nature bingo items that were found and not found in the schoolyard.
5. Ask the participants to suggest items for future bingo cards that were not listed. Small prizes/treats could be provided for those who get bingo.

Extension

Question Trail

Adapted from *Exploring The Outdoors With Aldo Leopold*, Pheasants Forever.

Objective: To improve observation skills and practice formulating testable questions.

Supplies: Blank tags with string, pencils

Activity: Give each participant a tag and a pencil, and inform them of the boundaries of activity. Allow them to wander along the trail and come up with a question about something they see. Do not allow simple questions like, "What is this called?" but instead encourage more investigative questions such as, "Why is this bark different on the branch than on the trunk?" How did this cob of corn end up in the woods?" How did this squirrel die and what will happen to it?" When participants come up with a question, they should write the question on the tag and hang it from the questioned object or nearby.

Then, gather all participants at the head of the trail and walk down the trail addressing one question at a time. At each tag, facilitate a discussion on how to make the question listed into something they could test or investigate.

EXPLORERS SCAVENGER HUNT

Objective

To explore the schoolyard to find a variety of natural and human-made items.

Supplies

Explorers' nature journals

Pencils

Activity

1. Refer to *Scavenger Hunt* in the Explorers' nature journal (page 22), for items to find around the schoolyard.
2. Review and discuss each item before going outside.
3. Record in writing or with a sketch the items found around the schoolyard and surrounding area.
4. When done searching, ask the following questions: What are some additional items not included on the scavenger hunt form? What things are alike? Which ones are different?
5. Refer to the activity *Nature Observation Basics* for more ideas on making observations.

Note: Other items to include on the scavenger hunt might be something: green, with needles, twisted, curly, round, sticky; a seed, tree bark on the ground, feather, pinecone, something flat, something smooth, rough, red, a flower, leaf, dead twig, weed, or ant. Also, ask participants to compare two different areas such as a sidewalk/paved area to grassy/natural area. List the things that are similar and different between these sites.

Extensions

Nature Alphabet Search

Objective: To search nature items and find each letter of the alphabet.

Supplies: Digital camera (optional), Explorers' nature journals, pencils

Activity: This activity can be completed as a group or individually. Groups and individuals can be assigned groups of letters (i.e. A-F, G-L, M-R, S-Z) to search for. The 26 letters of alphabet can be printed on a sheet of paper to assist with the activity. Provide examples of what different letters might look like in nature before going outside. For example, a branched twig might look like the letters V or Y. The nature letter can be captured with photos or the participants can sketch the items in their journals. Ask, which letters were easy to find? Are there common patterns and shapes found in nature?

Scavenger Hunt with a Twist

Objective: To foster reflection on scientific objectivity.

Supplies: Value-laden words on index cards

Activity: Give participants cards with a value-laden word such as gross, unnecessary, special or valuable and instruct them to find something in nature that their word describes. Have each participant show his or her finding to the group and explain how the word describes the object. Were there participants who couldn't find something for their word? Does everyone agree with

everyone else's choices? To what extent do our values predict and/or dictate our actions? What impact do our values have on how we view nature? How can you, as a scientist, remove human values from your descriptions of nature? Should you?

Nature Wristband

Objective: To create a wristband of natural items collected from the schoolyard.

Supplies: Tape (masking tape, duct tape or packing tape), natural items like small rocks, seeds, small leaves, pine needles, flowers, sticks, etc.

Activity: Measure around the participant's wrist and cut a piece of tape slightly larger than the wrist to fit over the hand. The tape needs to be sticky side out. Identify an area outside to collect natural items to stick to the wristbands. Do not stick live insects to the wristband. Try to find items on the ground versus picking them off plants. Ask the following questions: What did you find? Where did the items come from? Compare the wristbands and look for similarities and differences in natural items found. Encourage the participants to make a nature wristband at home and compare it with the one they just made.

Note: Natural items can be collected prior to class and this activity can be completed indoors.

REFERENCES

Edwards YMCA Camp. *Winter Wildlife*. Retrieved on January 13, 2015 from <http://www.campedwards.org/images/Winter%20Wildlife.pdf>.

Jeffers Foundation. (2010). *Ecotime: Integrating Environmental Education*. Prior Lake, MN: Jeffers Foundation.

Leopold Education Project. (2009). *Exploring the Outdoors with Aldo Leopold*. Pheasants Forever.

Minnesota DNR Division of Forestry. (2002). *Teacher's Guide to Arbor Month: Activities on Trees and the Natural World for Grades K-8*. St. Paul, MN: Minnesota DNR.

Monarch Lab, University of Minnesota. *Keeping a Journal*. Retrieved on January 20, 2015 from http://monarchlab.org/images/uploads/curricula/Keeping_a_Journal_LC36.pdf.

Strauss, A.L., Homayoun, T., Meyer, R., Nippolt, P.L., Oberhauser, K., Peterson, C., Rager, A. & Young-Isebrand, E. (2015). *Driven to Discover: Facilitator's Guide to Citizen Science*. St. Paul, MN: University of Minnesota Extension.

Upham Woods Outdoor Learning Center. (2006). *Animal Signs*. Wisconsin Dells, WI: Upham Woods Outdoor Learning Center.

Vermont Institute of Natural Science. (1986). *Hands-On Nature: Information and Activities for Exploring the Environment with Children*. Woodstock, Vermont: Vermont Institute of Natural Science.

Young-Isebrand, E. & Oberhauser, K. *Schoolyard Ecology Explorations: an Inquiry-Based Curriculum*. St. Paul, MN: University of Minnesota.