



NRIC

National  
Reactor  
Innovation  
Center



# Advanced Reactor Concepts and Safety Overview

March 22, 2022

Ashley E. Finan, Ph.D., NRIC director

[ashley.finan@inl.gov](mailto:ashley.finan@inl.gov)

[nric.inl.gov](http://nric.inl.gov)



# Advanced Fission

- Categorized in terms of capacity
  - Microreactors:  $\sim < 50$  MWe
  - Small reactors:  $\sim < 300$  MWe (SMRs use modular construction)
  - Medium reactors: 300 MWe - 700 MWe
  - Large reactors:  $> 700$  MWe
- Variety of coolants ( gas, sodium, salt, lead, water, etc.)
- Clean, high availability
- Diverse markets
- Improved safety, waste, security, and target economics
- 60+ private sector projects

Image courtesy of GAIN and Third Way, inspired by the Nuclear Energy Reimagined concept led by INL. Learn more about these and other energy park concepts at [thirdway.org/blog/nuclear-reimagined](https://thirdway.org/blog/nuclear-reimagined)

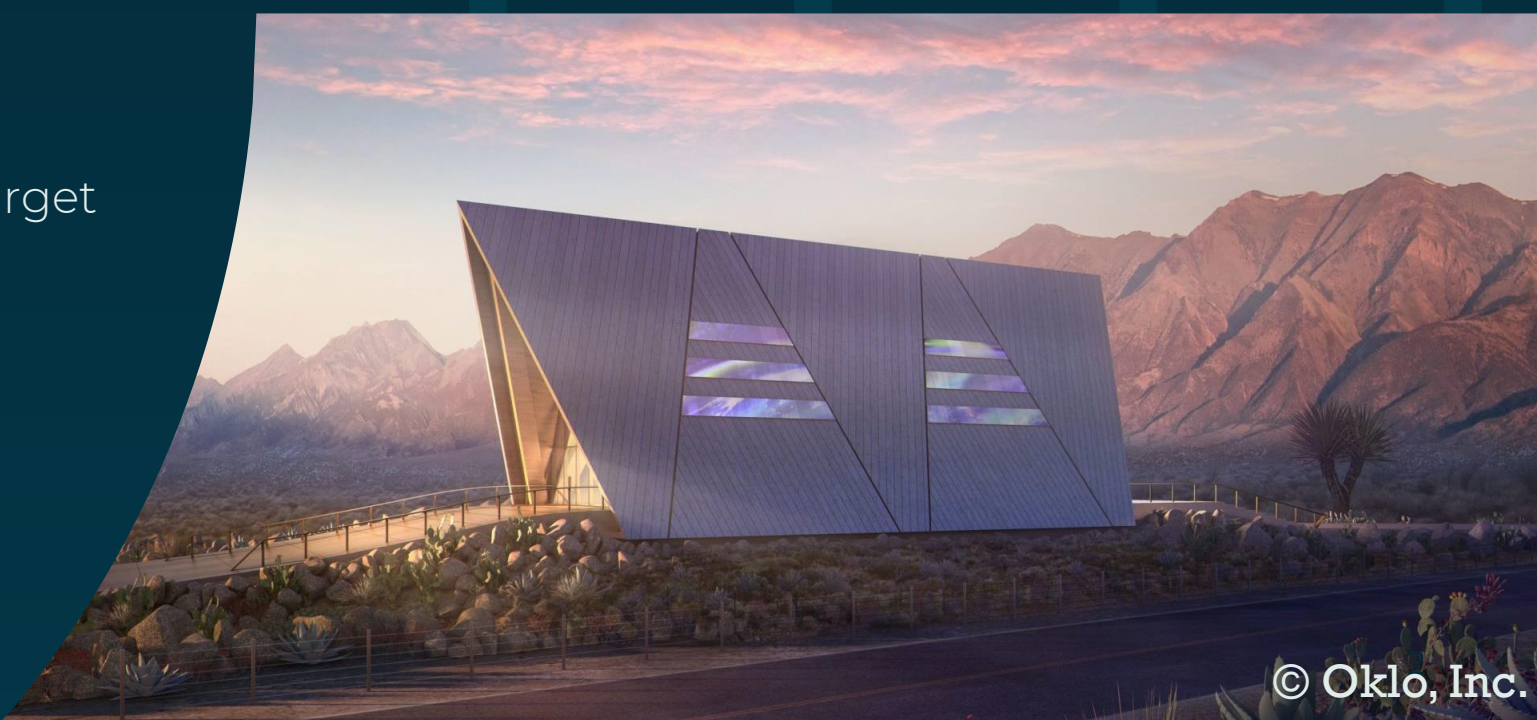

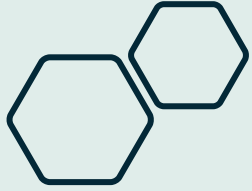

# Advanced Reactor Design Types

- High temperature gas reactors (helium coolant; TRISO fuel)
- Sodium fast reactors (sodium cooled)
- Lead fast reactors (lead cooled)
- Salt-cooled reactors (solid fuel with molten salt coolant)
- Molten salt-fueled reactors (liquid fuel)
- Water-cooled reactors
- Other variations

# U.S. Nuclear Safety Oversight

U.S. Nuclear Regulatory Commission (NRC)

NRC Mission:

The NRC licenses and regulates the Nation's civilian use of radioactive materials to provide reasonable assurance of adequate protection of public health and safety and to promote the common defense and security and to protect the environment.

NRC Principles of Good Regulation:

Independence  
Openness  
Efficiency  
Clarity  
Reliability

NRC Philosophy of Defense-in-Depth: use of multiple independent, diverse, and redundant layers of defense

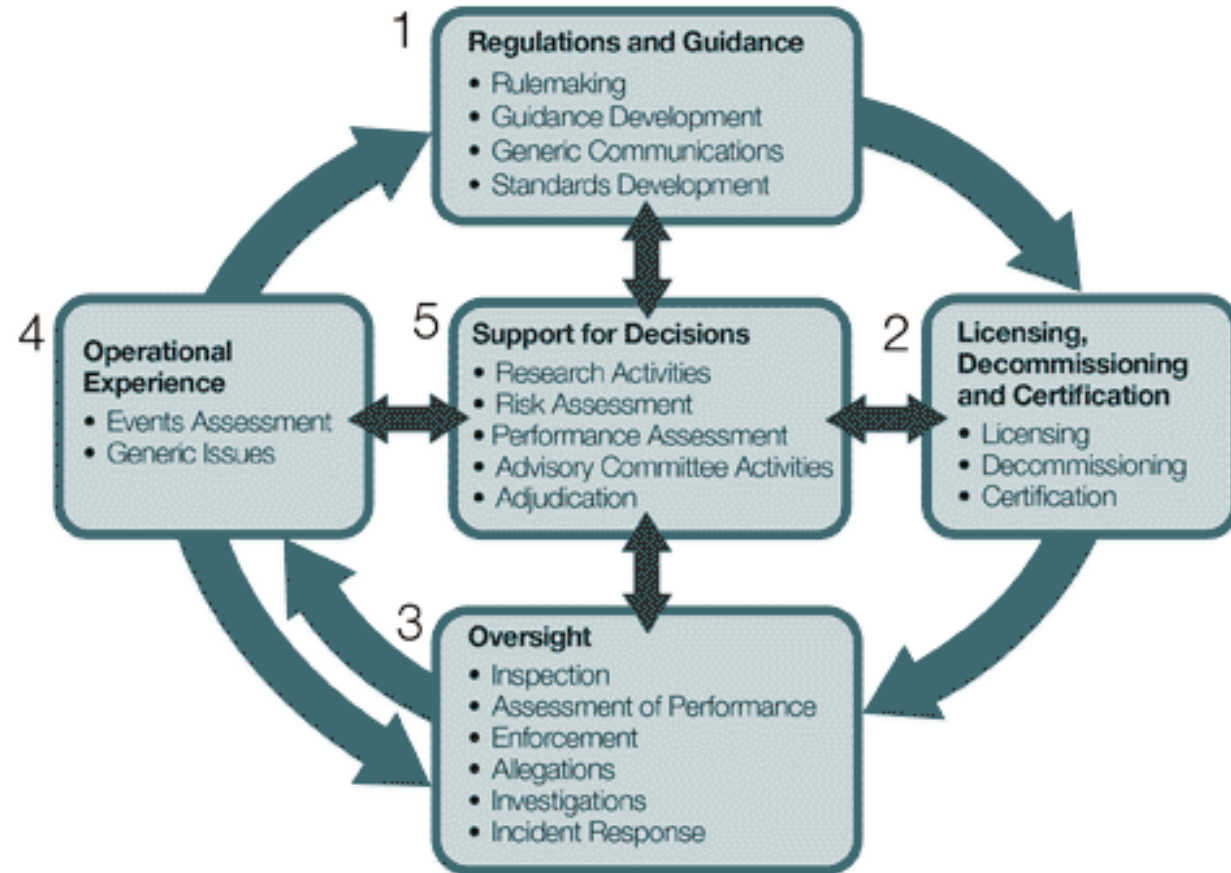

1. Developing regulations and guidance for applicants and licensees.
2. Licensing or certifying applicants to use nuclear materials, operate nuclear facilities, and decommission facilities.
3. Inspecting and assessing licensee operations and facilities to ensure licensees comply with NRC requirements, responding to incidents, investigating allegations of wrongdoing, and taking appropriate followup or enforcement actions when necessary.
4. Evaluating operational experience of licensed facilities and activities.
5. Conducting research, holding hearings, and obtaining independent reviews to support regulatory decisions.

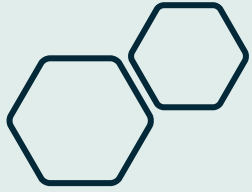

# Nuclear energy safety basics

- Goal: Prevent offsite release of radioactive materials
- Risk = likelihood of event x consequences or severity
- Primary concern is damage to fuel and subsequent release of radioactivity.
- Several possible causes of problematic fuel damage exist. Most relate to overheating.

\*other goals, concerns, and causes exist; this presentation will focus on those highlighted here as they are safety considerations of high importance

# Traditional Pressurized Water Reactor Diagram

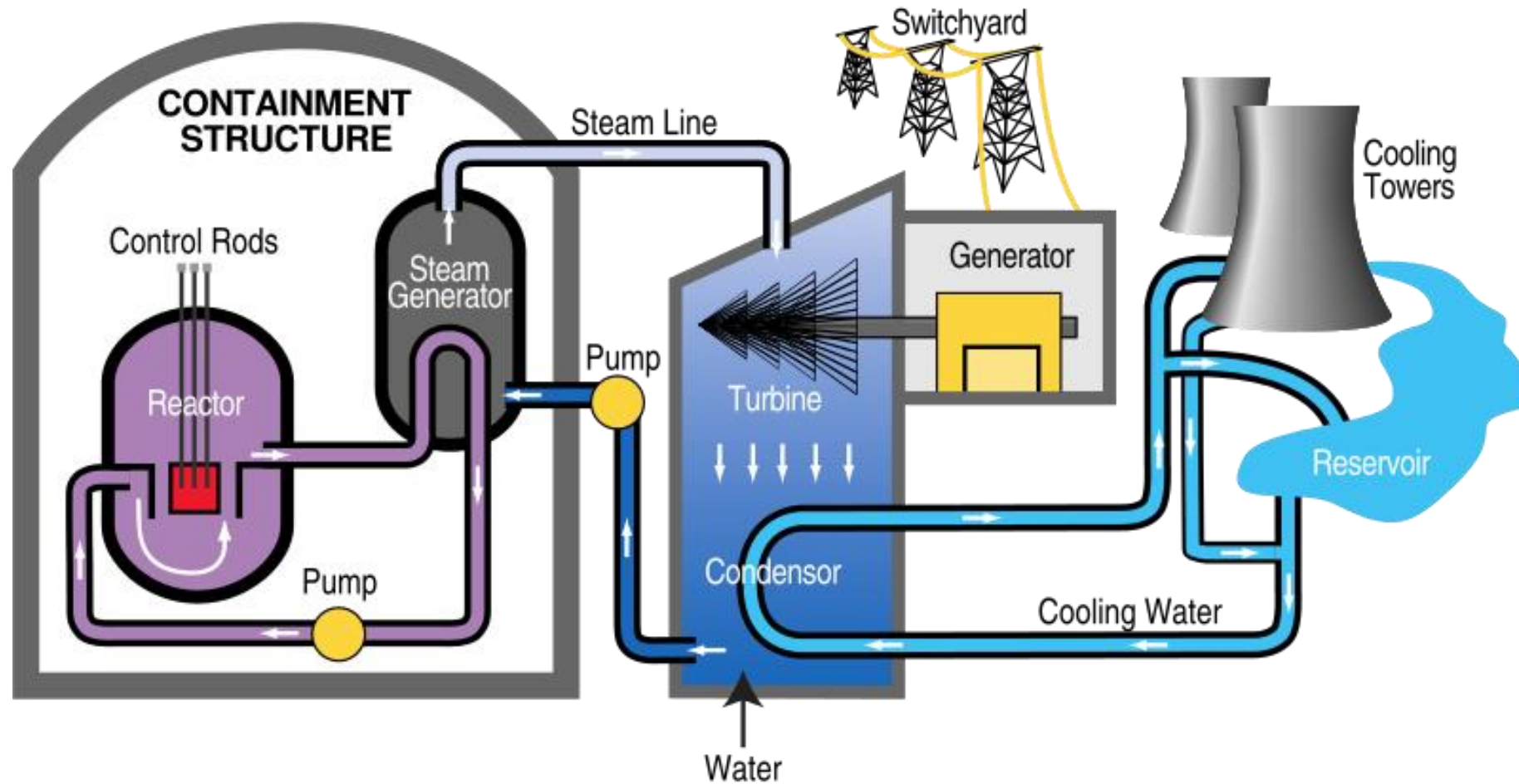

Pressurized Water Reactor Diagram (Source: Tennessee Valley Authority)

# Very High Temperature Reactor (VHTR)

(High Temperature Gas Reactor)

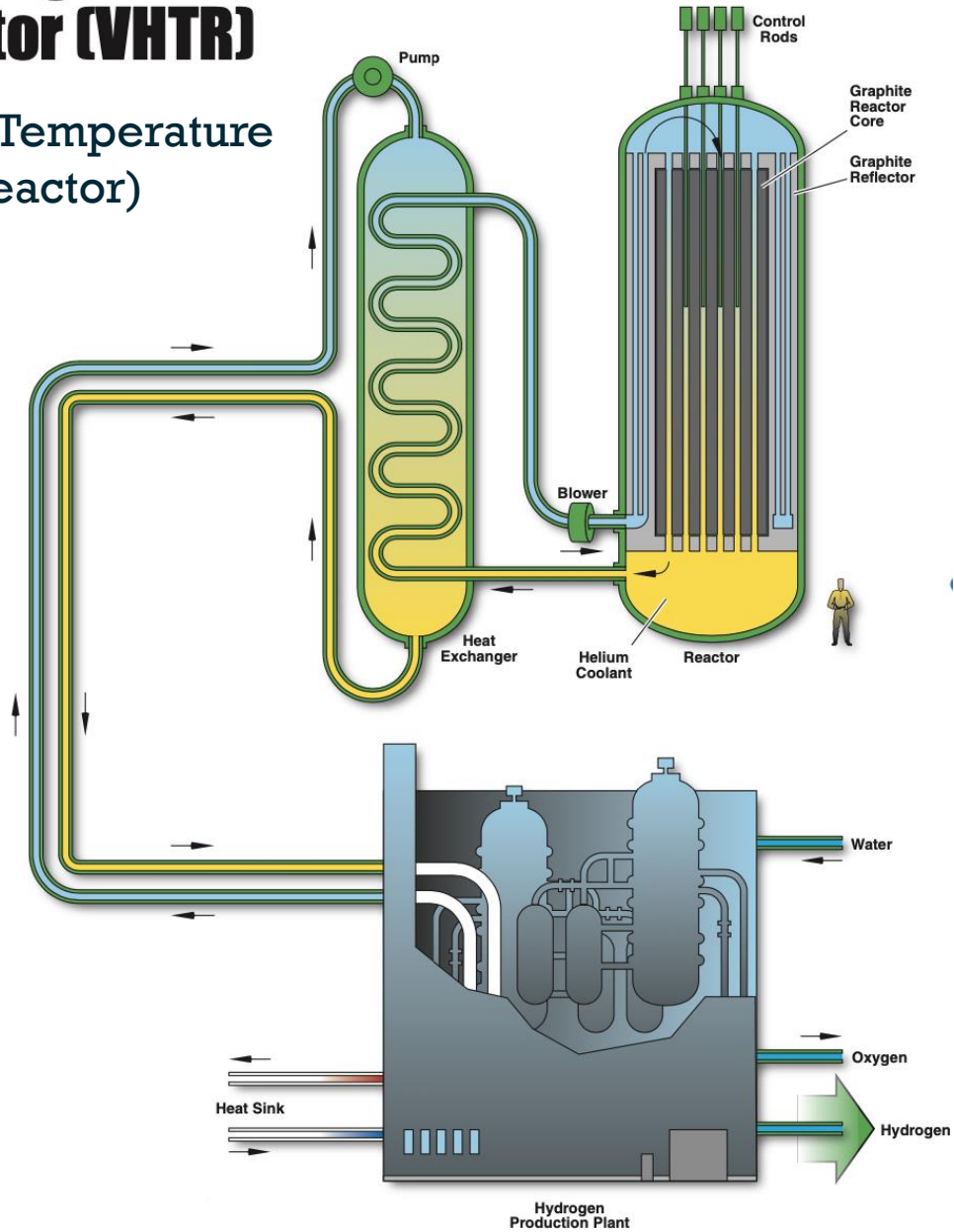

# Sodium-Cooled Fast Reactor (SFR)

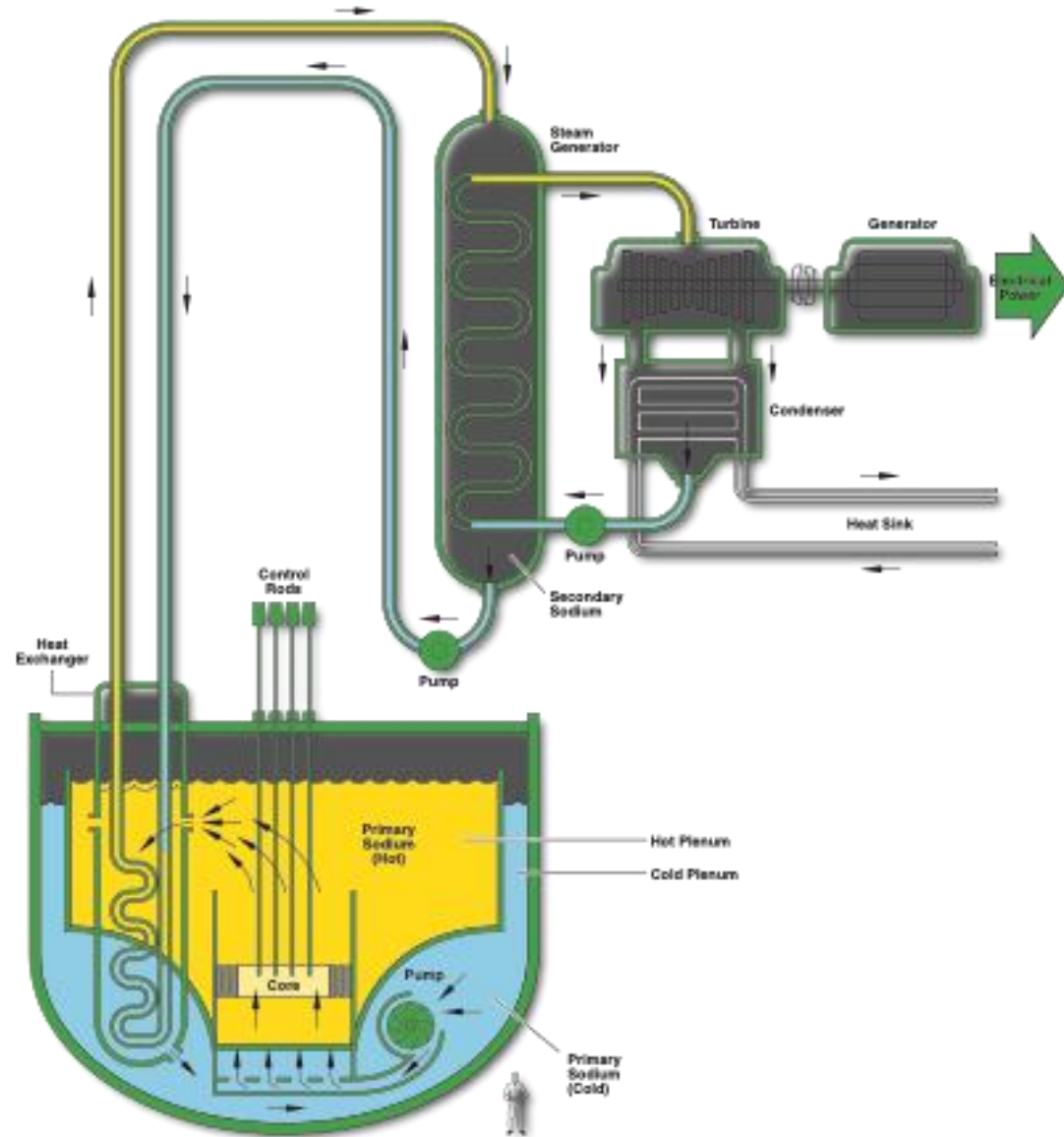

# Preventing fuel damage

	Traditional approaches	Innovations & Enhancements
Control Reactor Power	<ul style="list-style-type: none"> <li>- Inherent safety in reactor physics design (negative reactivity feedback)</li> <li>- Mechanical shutdown such as control rods and boron injection</li> </ul>	Traditional approaches plus, in some cases, online refueling or fast spectrum to enable lower excess reactivity in reactor core
Maintain Cooling	<ul style="list-style-type: none"> <li>- Several active cooling systems (high-pressure and low-pressure injection systems, containment spray, etc.)</li> <li>- Backup diesel generators for pump operation</li> </ul>	<ul style="list-style-type: none"> <li>- Gravity-driven backup cooling</li> <li>- Battery backups for key controls/valves</li> <li>- Passive natural circulation approaches</li> <li>- Coolants with higher heat capacity, high boiling point, and low-pressure operation to prevent coolant loss</li> <li>- Increased/indefinite coping time without electric power</li> <li>- Simplify design</li> <li>- Reduce operation actions</li> </ul>



# Confining Radioactive Materials

	Traditional approaches	Innovations & Enhancements
Physical Containment/Confinement Approaches	<ul style="list-style-type: none"><li>- Large concrete/steel containment structure to withstand internal pressure and external or internal impacts</li><li>- Manage hydrogen buildup</li></ul>	<ul style="list-style-type: none"><li>- Low pressure operation to prevent coolant loss and avoid driving force for dispersion</li><li>- Manage chemical interactions &amp; minimize hydrogen buildup (e.g. accident tolerant fuels)</li><li>- Advanced fuels such as TRISO that retain radioactive materials</li></ul>
Reduce inventory available for release		<ul style="list-style-type: none"><li>- higher efficiency operation using less fuel</li><li>- smaller units</li><li>- Online refueling and/or fission product removal</li></ul>

# Tristructural Isotropic (TRISO) Coated Particle Fuel

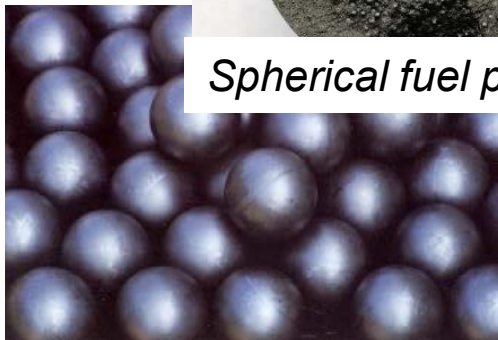
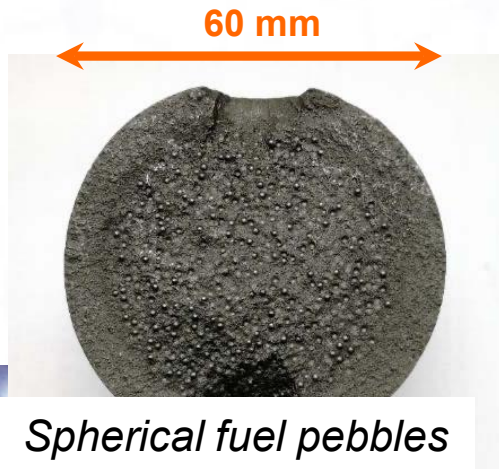
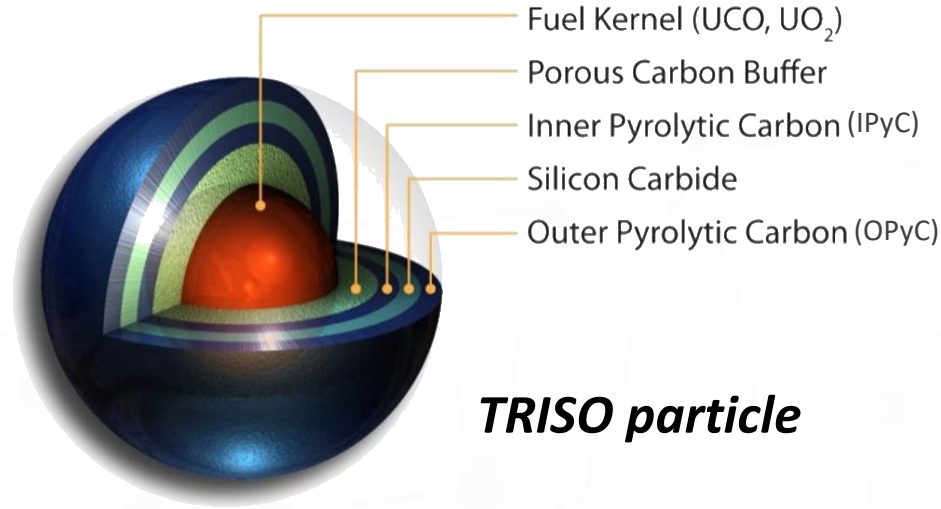

Particle design provides excellent fission product retention in the fuel and is at the heart of the safety basis for high temperature gas reactors



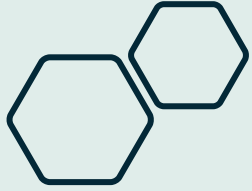

# Summary

- Civilian nuclear power is regulated by the U.S. NRC
- Most safety measures focus on preventing damage to the fuel or release of radioactive materials if damage should occur
- Advanced reactors include safety enhancements and innovations that rely more on inherent and passive features and less on active engineered systems
- Both traditional and advanced systems implement a defense-in-depth philosophy

**Thank you!**  
**Questions?**